



Dell™ Inspiron™ 5000 Series

[Technical Overview](#)

[Removing and Replacing Parts](#)

[Drivers and Utilities for Microsoft Windows
98](#)

[Drivers and Utilities for Microsoft Windows
2000](#)

[Drivers and Utilities for Microsoft Windows
Me](#)

[Conserving Power](#)

[System Setup Program](#)

[System Messages](#)

[Ports and Connectors](#)

[Technical Specifications](#)

[Documentation Links](#)



Model PPM

Information in this document is subject to change without notice.
© 2000–2001 Dell Computer Corporation. All rights reserved.

Reproduction in any manner whatsoever without the written permission of Dell Computer Corporation is strictly forbidden. Trademarks used in this text: *Dell*, the *DELL* logo, and *Inspiron* are trademarks of Dell Computer Corporation; *Microsoft*, *Windows*, *MS-DOS*, and *Windows NT* are registered trademarks of Microsoft Corporation; *Intel* and *Pentium* are registered trademarks, and *Celeron* and *Intel SpeedStep* are trademarks of Intel Corporation; *Adobe* is a trademark of Adobe Systems Incorporated, which may be registered in certain jurisdictions.

Other trademarks and trade names may be used in this document to refer to either the entities claiming the marks and names or their products. Dell Computer Corporation disclaims any proprietary interest in trademarks and trade names other than its own.

[Back to Contents Page](#)

Documentation Links: Dell™ Inspiron™ 5000 Series

 [Printed Documentation](#)

 [Online Documentation](#)

Printed Documentation

 You must right-click the link for a portable document format (PDF) file and save the file to your hard-disk drive. Attempting to link directly to large PDF files causes your system to freeze.

To save PDF files (files with an extension of **.pdf**) to your hard-disk drive, right-click the document title, click **Save Target As** in Microsoft® Internet Explorer or **Save Link As** in Netscape Navigator, and specify a location on your hard-disk drive.

 **NOTES:** PDF files require Adobe™ Acrobat Reader, which can be downloaded from the from the Adobe World Wide Web site at: <http://www.adobe.com/acrobat/>.

To view a PDF file, launch Acrobat Reader. Click **File** → **Open** and select the PDF file.

Right-click only the following links:

Document Title	File Format	File Size
Getting Started Inspiron 5000	.pdf	815 KB
Start Here Inspiron 5000e	.pdf	397 KB
Dell Inspiron Systems Setup Guide	.pdf	412 KB
Dell Inspiron 5000 Reference and Troubleshooting Guide	.pdf	2.14 MB
Dell Inspiron 5000 Port Replicator User's Guide	.pdf	949 KB
Dell Inspiron 5000e System Solutions Guide	.pdf	1.78 MB
Removing and Replacing Parts	.pdf	2.23 MB

Online Documentation

Inspiron 5000

 Compiled HTML Help files (files with an extension of **.chm**) require Microsoft Internet Explorer 4.0 or later.

Downloading the Help and Associated Files

1. Right-click the following link to the **popup.ocx** file: [popup.ocx](#)
2. Click **Save Target As** in Microsoft Internet Explorer or **Save Link As** in Netscape Navigator, and specify **c:\windows\system** for Windows 98 or **c:\winnt** for Windows NT on your hard-disk drive.
3. Click the **Start** button on the Microsoft Windows® desktop, and then click **Run**.
4. Type **regsvr32 popup.ocx** and then press <Enter>.
5. Click **OK** when the installation is complete.

Downloading the Help File

1. Click the appropriate button to download the zipped file and save it to your hard-disk drive.

English

français

Deutsch

Italiano

日本語

2. Go to the directory location you specified when you saved the file.
3. Double-click the **.exe** file you downloaded. The **WinZip Self-Extractor** dialog box appears.
4. Specify the location to save the unzipped files to and click **Unzip**. A message stating that the files unzipped successfully appears.
5. Click **OK**.
6. Click **Close**.

Viewing the Help File

1. Start your browser and open the **index.htm** file in the directory containing the unzipped files.
2. Click the **Start** button on the Windows desktop, point to **Programs**, and then click **Windows Explorer**.
3. Navigate to the directory in which you saved the Help file.
4. Double-click the file.

Inspiron 5000e



Compiled HTML Help files (files with an extension of .chm) require Microsoft Internet Explorer 4.0 or later.

Downloading the Help and Associated Files

1. Click the following link to download the **help_dll.exe** file: [help_dll.exe](#)
2. Save the link to the default directory, **c:\windows\system32**.
3. Go to the directory location you specified when you saved the file.
4. Double-click the **.exe** file you downloaded. The **WinZip Self-Extractor** dialog box appears.
5. Specify the location to save the unzipped files to and click **Unzip**. A message appears, stating that the files unzipped successfully.
6. Click **OK**.
7. Click **Close**.

Downloading the Help File

1. Click the appropriate button to download the zipped file and save it to your hard-disk drive.

English

français

Deutsch

Italiano

日本語

Español

简体中文

2. Go to the directory location you specified when you saved the file.
3. Double-click the **.exe** file you downloaded. The **WinZip Self-Extractor** dialog box appears.
4. Specify the location to save the unzipped files to and click **Unzip**. A message appears, stating that the files unzipped successfully.
5. Click **OK**.
6. Click **Close**.

Viewing the Help File

1. Start your browser and open the **index.htm** file in the directory containing the unzipped files.
 2. Click the **Start** button on the Windows desktop, point to **Programs**, and then click **Windows Explorer**.
 3. Navigate to the directory in which you saved the Help file.
 4. Double-click the file.
-

[Back to Contents Page](#)

[Back to Contents Page](#)

Drivers and Utilities for Microsoft® Windows® 2000: Dell™ Inspiron™ 5000 Series

 [Overview](#)

 [System Software CD](#)

 [Installing Windows 2000](#)

 [Installing the Audio Driver](#)

 [Installing the Video Driver](#)

 [Installing the Touch Pad Driver](#)

 [Installing the Software DVD Decoder Driver \(Optional\)](#)

 [Installing the Intel SpeedStep Utility \(Optional\)](#)

 [Updating Drivers and Utilities](#)

Overview

This section explains how to install or reinstall Dell-provided device drivers and utilities on your Dell computer running the Microsoft Windows 2000 operating system. You may need to use this information under the following conditions:

- 1 You are reinstalling the Windows operating system.
- 1 You are reinstalling the Dell-provided drivers and utilities.
- 1 You installed a new primary hard-disk drive and you must install all of the system software.

Installing Drivers and Utilities for Windows

To install the system software, you need the following items:

- 1 *System Software* CD
- 1 CD-ROM or DVD-ROM drive installed in the media bay of the computer



NOTE: The drivers on the System Software CD are the same drivers that Dell installed on your hard-disk drive before shipping the computer to you. To download the latest versions of these drivers, visit the Dell support Web site at <http://support.dell.com>.

System Software CD

The following figure shows the directory structure of the *System Software* CD for Inspiron 5000 series computers. The CD is bootable. The R:\> prompt appears when you exit to MS-DOS® from the **Diagnostics** menu.

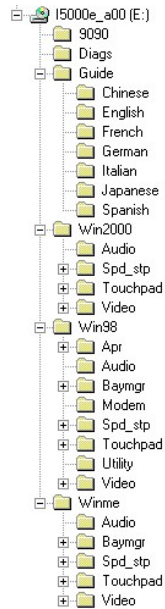

Installing Windows 2000

Perform the following steps to install the Windows 2000 operating system on the hard-disk drive before you install any device drivers or utilities:

1. Insert the *Dell Products Recovery* CD into the CD-ROM or DVD-ROM drive.
2. Shut down the computer.
3. Turn on the computer.
4. Press any key when the `Press any key to boot from CD` message appears on the screen.
5. When the **Windows 2000 Setup** window appears, ensure that the **To setup Win2000 now, press ENTER** option is highlighted. Then press <Enter>.
6. Read the information in the **License Agreement** window, and then press <F8> to continue.
7. When the **Windows 2000 Professional Setup** window appears, press the arrow keys to select the Windows 2000 partition option that you want. To continue, press the key specified in the partition option that you chose.
8. When the **Windows 2000 Professional Setup** window reappears, press the arrow keys to select the type of filing system that you want Windows 2000 to use, and then press <Enter>.
9. Press <Enter> again to restart your computer.
10. Click **Next** when the **Welcome to the Windows 2000 Setup Wizard** window appears.
11. When the **Regional Settings** window appears, select the settings for your locale, and then click **Next**.
12. Enter your name and organization in the **Personalize Your Software** window, and then click **Next**.
13. When prompted, enter the Windows product key, which is printed on the Microsoft label on your computer. Then click **Next**.
14. When the **Computer Name and Administrator Password** window appears, enter a name for your computer and a password, if desired. Then click **Next**.
15. Enter the date and time in the **Date and Time Settings** window, and then click **Next**.

Windows 2000 now begins to install its components and configure the computer.

17. When the **Completing the Windows 2000 Setup Wizard** window appears, remove the CD from the drive, and then click **Finish**. The computer automatically restarts.

Installing the Audio Driver

The audio driver allows you to customize the sound features of your computer.

1. Save and close any open files, and exit any open application programs.
2. Insert the *System Software* CD into the CD-ROM or DVD-ROM drive.
3. Click the **Start** button, and then click **Run**.
4. In the **Run** dialog box, type `x:\win2000\audio\setup.exe`, where `x` is the CD-ROM or DVD-ROM drive letter.

The CD-ROM or DVD-ROM drive letter is usually *D*.

5. Click **OK**.
6. In the **Welcome** window, click **Next>**.

An information dialog box appears, stating that the audio driver is installed on your computer.

7. Click **OK**.
8. When prompted, ensure that **Yes, I want to restart my computer now** is selected, and then click **Finish**.



NOTE: If the computer is set to boot from the CD-ROM or DVD-ROM drive before the hard-disk drive, remove the System Software CD before the computer restarts so that the computer does not boot from the CD. For information on changing the boot sequence, see "[System Setup Program](#)."

The audio drivers are installed, and the installation is complete.

Installing the Video Driver

The video driver controls video resolution and color palette.



NOTE: If you need to use extended video modes, check the documentation that accompanied the application program to determine if the driver is provided. If it is not, contact the software manufacturer for the necessary driver.

1. Save and close any open files, and exit any open application programs.
2. Insert the *System Software* CD into the CD-ROM or DVD-ROM drive.
3. Click the **Start** button, and then click **Run**.
4. In the **Run** dialog box, type `x:\win2000\video\setup.exe`, where `x` is the CD-ROM or DVD-ROM drive letter.

The CD-ROM or DVD-ROM drive letter is usually *D*.

5. In the **Setup Complete** window, ensure that **Yes, I want to restart my computer now** is selected, and then click **Finish**.

The computer restarts automatically.



NOTES: If the computer is set to boot from the CD-ROM or DVD-ROM drive before the hard-disk drive, remove the System Software CD before the computer restarts so that the computer does not boot from the CD. For information on changing the boot sequence, see "[System Setup Program](#)."

After the computer restarts, you can change the video resolution.

Installing the Touch Pad Driver

The touch pad driver controls touch pad and mouse functions.



NOTE: When you are prompted to select a directory, Dell recommends using the default directory settings.

1. Save and close any open files, and exit any open application programs.
2. Insert the *System Software* CD into the CD-ROM or DVD-ROM drive.

3. Click the **Start** button, and then click **Run**.
4. In the **Run** dialog box, type `x:\win2000\touchpad\english\setup.exe`, where *x* is the CD-ROM or DVD-ROM drive letter.

If you are using a Japanese-language version of Windows, type `x:\win2000\touchpad\japanese\setup.exe`, where *x* is the CD-ROM or DVD-ROM drive letter.

The CD-ROM or DVD-ROM drive letter is usually *D*.

NOTICE: Do not install the Japanese-language driver on a computer with a non-Japanese-language operating system.

5. Click **Unzip**.
6. Click **OK**.
7. In the **Welcome** window, click **Next>**.
8. At the **Important Information** window, click **Next>** twice.
9. At the **Start Copying Files** window, click **Next>**.

The touch pad driver is copied to your hard-disk drive.

10. At the **Setup Complete** window, be sure that the **Yes, I want to restart my computer now** button is selected, and then click **Finish**.

The **Information about your Touch Pad** window appears. If you do not want this window to appear each time you start the computer, remove the check from the box that says **Show this message the next time Windows starts**. Then click **Close**.

 *NOTE: If the computer is set to boot from the CD-ROM or DVD-ROM drive before the hard-disk drive, remove the System Software CD before the computer restarts so that the computer does not boot from the CD. For information on changing the boot sequence, refer to "[System Setup Program](#)."*

Installing the Software DVD Decoder Driver (Optional)

The DVD decoder driver allows you to play DVD movies using your DVD-ROM drive on the computer.

 *NOTE: When you are prompted to select a directory, Dell recommends that you use the default directory setting.*

1. Insert the *Software DVD Decoder* CD into the DVD-ROM drive.

The installation program starts automatically and the **Choose Setup Language** window appears.

 *NOTE: If the installation program does not start automatically, navigate to the Software DVD Decoder CD and click the **Setup** icon.*

2. Select **English**, and then click **OK**.

The **Welcome** screen appears.

3. Click **Next>**.

The **Software License Agreement** window appears.

4. Click **Yes**.

The **Choose Destination** window appears.

5. Click **Next>**.

The files are copied to your disk and the **setup Complete** window appears.

6. Ensure that the **Yes, I want to restart my computer now** is selected, and then click **Finish**.

Your computer restarts and the desktop appears.

7. Insert your DVD into the DVD-ROM drive.

When you start your DVD for the first time, a **Warning** dialog box appears, explaining that DVD playback performance is dependent on your overall system configuration and that some DVD titles are protected with an antitaping product provided by Macrovision, Inc.



NOTES: A variety of factors determine the DVD's playback performance. For more information, read the "Requirements" section in the release notes that came with your DVD software.

The Macrovision product allows you to view your DVD on most televisions, but it distorts the video image if played back from a videotape. The DVD decoder software provided with your system does not allow you to play back DVDs with graphics cards that contain a TV-out connector.

If you have a TV-out connector on your computer and your DVD-ROM drive does not play your DVD title, make sure the TV-out feature in your graphics card's software is turned off. Dell does not currently provide a TV-out connector as an accessory item.

8. Click **OK**.

Setting and Changing the DVD-ROM Drive Code

If you reinstall the DVD decoder software, you must set the DVD-ROM drive region code before you can play a movie. The region code can be reset if you relocate to another region.

NOTICE: You should reset the region code only when absolutely necessary. You can reset the region code up to four times.

To reset the drive region code, perform the following steps:

1. Insert a DVD coded for the new region into the DVD-ROM drive.

A notification box appears, explaining that the disc belongs to another region and cannot be played. The notification also explains how to reset the region setting.

2. Follow the instructions on the screen to change the region setting.

Installing the Intel® SpeedStep™ Utility (Optional)

NOTICE: Do not install the Intel SpeedStep utility unless your computer has a Mobile Intel Pentium® III processor with Intel SpeedStep technology. To determine if your computer has a Mobile Intel Pentium III processor with Intel SpeedStep technology, check for the Intel SpeedStep item in the Power menu of the system setup program. For instructions on using the system setup program, see "[System Setup Program](#)."

If your computer has a Mobile Intel Pentium III processor with Intel SpeedStep technology, you must reinstall the Intel SpeedStep utility after you install a new hard-disk drive or reformat your hard-disk drive.

1. Save and close any open files, and exit any open application programs.
2. Insert the *System Software* CD into the CD-ROM or DVD-ROM drive.
3. Click the **Start** button, and then click **Run**.
4. In the **Run** dialog box, type `x:\win2000\spd_stp\english\setup.exe`, where *x* is the CD-ROM or DVD-ROM drive letter.

The CD-ROM or DVD-ROM drive letter is usually *D*.

5. Click **OK**.
6. In the **Welcome** window, click **Next>**.
7. At the **Setup Complete** window, ensure that the **Yes, I want to restart my computer now** is selected, and then click **Finish**.



NOTE: If the computer is set to boot from the CD-ROM or DVD-ROM drive before the hard-disk drive, remove the System Software CD before the computer restarts so that the computer does not boot from the CD. For information on changing the boot sequence, refer to "[System Setup Program](#)."

Updating Drivers and Utilities

The Dell support Web site, <http://support.dell.com>, provides driver and utility updates, as well as technical assistance with questions about your computer. Dell regularly tests and releases certified drivers and utilities for Inspiron computers. In addition, if you have access to a computer with a modem and/or fax capabilities, you can access the Dell TechConnect bulletin board service (BBS), AutoTech service, and TechFax service. The Dell Web site, <http://www.dell.com>, also contains links to these services.

[Back to Contents Page](#)

[Back to Contents Page](#)

Drivers and Utilities for Microsoft® Windows® Me: Dell™ Inspiron™ 5000 Series

[Overview](#)

[System Software CD](#)

[Installing Windows Me](#)

[Installing the Audio Driver](#)

[Installing the Video Driver](#)

[Installing the Touch Pad Driver](#)

[Installing Softex BayManager](#)

[Installing the Intel SpeedStep Utility \(Optional\)](#)

[Updating Drivers and Utilities](#)

Overview

This section explains how to install or reinstall Dell-provided device drivers and utilities on your Dell computer running the Microsoft Windows Millennium Edition (Me) operating system. You may need to use this information under the following conditions:

- 1 You are reinstalling the Windows operating system.
- 1 You are reinstalling the Dell-provided drivers and utilities.
- 1 You installed a new primary hard-disk drive and you must install all of the system software.

Installing Drivers and Utilities for Windows

To install the system software, you need the following items:

- 1 *System Software* CD
- 1 CD-ROM or DVD-ROM drive installed in the media bay of the computer



NOTE: The drivers on the System Software CD are the same drivers that Dell installed on your hard-disk drive before shipping the computer to you. To download the latest versions of these drivers, visit the Dell support Web site at <http://support.dell.com>.

System Software CD

The following figure shows the directory structure of the *System Software* CD for Inspiron 5000 series computers. The CD is bootable. The R : \> prompt appears when you exit to MS-DOS® from the **Diagnostics** menu.

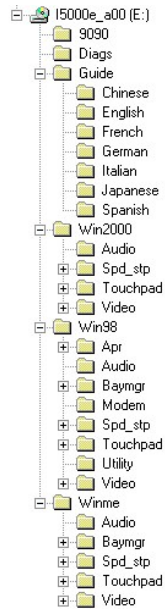

Installing Windows Me

Perform the following steps to install the Windows Me operating system on the hard-disk drive before you install any device drivers or utilities:

1. Turn on the computer and enter the system setup program.
2. In the system setup program **Boot** menu, change the boot sequence so that the CD or DVD drive boots first. Then place the *Dell Product Recovery* CD in the CD or DVD drive and close the drive tray.
3. Exit the system setup program.
4. At the **Welcome** window, click **OK**.
5. Double-click **Refresh Windows OS**.
6. Click **OK**.
7. Click **OK** again.
8. Remove the *Dell Product Recovery* CD from the CD or DVD drive, and click **OK** to restart your computer.

The **Getting ready to run Windows for the first time** window appears.

9. If the mouse tutorial starts, press <Esc> to exit, and then press <y>.
10. Click the regional setting closest to where you live, and click **Next**.
11. Click the graphic that matches your keyboard layout, and click **Next**.
12. In the **User Information** window, type your name and, if applicable, company name, and then click **Next**

The **Name** field must be completed; the **Company Name** field is optional.

The **License Agreement** window appears.

13. Click **I accept the Agreement**, and then click **Next**.
14. Type the Windows product key in the fields provided, and then click **Next**.

The product key is the bar code number found on the Microsoft Windows label, which is located on the computer.

15. When the **Start Wizard** appears, click **Finish**.

The **Enter Windows Properties** window appears. To continue without creating a Windows user name and password, click **OK**. Otherwise, type your user name and password in the appropriate fields and then click **OK**.

16. If the **Date/Time Properties** window appears, adjust the date and time properties, click **Apply**, and then click **OK**.

Windows updates the system settings and restarts your computer.

17. If you created a Windows user name and password, type your password and click **OK**.

NOTICE: Make sure that you reinstall the Intel® Chip Set Update Utility driver *before* you reinstall any other drivers.

18. Reinstall the appropriate drivers.

19. Reenable your virus protection software.

Installing the Audio Driver

The audio driver allows you to customize the sound features of your computer.

1. Save and close any open files, and exit any open application programs.
2. Insert the *System Software* CD into the CD-ROM or DVD-ROM drive.
3. Click the **Start** button, and then click **Run**.
4. In the **Run** dialog box, type `x:\winme\audio\setup.exe`, where *x* is the CD-ROM or DVD-ROM drive letter.

The CD-ROM or DVD-ROM drive letter is usually *D*.

5. Click **OK**.
6. In the **Welcome** window, click **Next>**.
7. On the **Main Menu**, **Upgrade Drivers** is selected. Click **Next>**.

The audio files are copied to your hard-disk drive.

8. When prompted, ensure that **Yes, I want to restart my computer now** is selected, and then click **Finish**.



NOTE: If the computer is set to boot from the CD-ROM or DVD-ROM drive before the hard-disk drive, remove the System Software CD before the computer restarts so that the computer does not boot from the CD. For information on changing the boot sequence, see "[System Setup Program](#)."

The **New Hardware Found** window appears, the software for the hardware is installed, and the installation is complete.

Installing the Video Driver

The video driver controls video resolution and color palette.



NOTE: If you need to use extended video modes, check the documentation that accompanied the application program to determine if the driver is provided. If it is not, contact the software manufacturer for the necessary driver.

1. Save and close any open files, and exit any open application programs.
2. Insert the *System Software* CD into the CD-ROM or DVD-ROM drive.
3. Click the **Start** button, and then click **Run**.
4. In the **Run** dialog box, type `x:\winme\video\setup.exe`, where *x* is the CD-ROM or DVD-ROM drive letter. The CD-ROM or DVD-ROM drive letter is usually *D*.



NOTE: DirectX is installed automatically if your computer needs it.

5. In the **Setup Complete** window, ensure that **Yes, I want to restart my computer now** is selected, and then click **Finish**.

The computer restarts automatically.



NOTES: If the computer is set to boot from the CD-ROM or DVD-ROM drive before the hard-disk drive, remove the System Software CD before the computer restarts so that the computer does not boot from the CD. For information on changing the boot sequence, see "[System Setup Program](#)."

After the computer restarts, you can change the video resolution.

Installing the Touch Pad Driver

The touch pad driver controls touch pad and mouse functions.



NOTE: When you are prompted to select a directory, Dell recommends using the default directory settings.

1. Save and close any open files, and exit any open application programs.
2. Insert the *System Software* CD into the CD-ROM or DVD-ROM drive.
3. Click the **Start** button, and then click **Run**.
4. In the **Run** dialog box, type `x:\winme\touchpad\english\setup.exe`, where `x` is the CD-ROM or DVD-ROM drive letter.

If you are using a Japanese-language version of Windows, type `x:\winme\touchpad\japanese\setup.exe`, where `x` is the CD-ROM or DVD-ROM drive letter.

The CD-ROM or DVD-ROM drive letter is usually `D`.

NOTICE: Do not install the Japanese-language driver on a computer with a non-Japanese-language operating system.

5. Click **OK**.
6. In the **Welcome** window, click **Next>**.
7. At the **Choose Destination Location** window, click **Next>**.
8. At the **Start Copying Files** window, click **Next>**.

The touch pad drivers are copied to your hard-disk drive.

9. At the **Setup Complete** window, be sure that the **Yes, I want to restart my computer now** button is selected, and then click **Finish**.

The **Information about your Touch Pad** window appears. If you do not want this window to appear each time you start the computer, remove the check from the box that says **Show this message the next time Windows starts**. Then click **Close**.



NOTE: If the computer is set to boot from the CD-ROM or DVD-ROM drive before the hard-disk drive, remove the System Software CD before the computer restarts so that the computer does not boot from the CD. For information on changing the boot sequence, see "[System Setup Program](#)."

Installing Softex BayManager

Softex BayManager is a utility that makes it possible to swap media bay devices without turning off the computer.

NOTICE: You must uninstall Softex BayManager before you download and install a Softex BayManager software upgrade from the Dell Support Web site File Library.

To uninstall Softex BayManager, perform the following steps:

1. Save and close any open files, and exit any open application programs.
2. Click **Start**, select **Settings**, and then click **Control Panel**.
3. Double-click **Add/Remove Programs**.
4. Select **Softex BayManager** and click **Add/Remove**.
5. Follow the instructions on the screen to complete the uninstall process.

To install the Softex BayManager from the *System Software* CD, perform the following steps:

1. Insert the *System Software* CD into the CD-ROM or DVD-ROM drive.
2. Click the **Start** button, and then click **Run**.
3. In the **Run** dialog box, type `x:\winme\baymgr\setup.exe`, where *x* is the CD-ROM or DVD-ROM drive letter.

The CD-ROM or DVD-ROM drive letter is usually *D*.

4. Click **OK**.
5. In the **Welcome** window, click **Next>**.
6. At the **Setup Complete** window, ensure that the **Yes, I want to restart my computer now** is selected, and then click **Finish**.



NOTE: If the computer is set to boot from the CD-ROM or DVD-ROM drive before the hard-disk drive, remove the System Software CD before the computer restarts so that the computer does not boot from the CD. For information on changing the boot sequence, see "[System Setup Program](#)."

Installing the Intel® SpeedStep™ Utility (Optional)

NOTICE: Do not install the Intel SpeedStep utility unless your computer has a Mobile Intel Pentium® III processor with Intel SpeedStep technology. To determine if your computer has a Mobile Intel Pentium III processor with Intel SpeedStep technology, check for the Intel SpeedStep item in the Power menu of the system setup program. For instructions on using the system setup program, see "[System Setup Program](#)."

If your computer has a Mobile Intel Pentium III processor with Intel SpeedStep technology, you must reinstall the Intel SpeedStep utility after you install a new hard-disk drive or reformat your hard-disk drive.

1. Save and close any open files, and exit any open application programs.
2. Insert the *System Software* CD into the CD-ROM or DVD-ROM drive.
3. Click the **Start** button, and then click **Run**.
4. In the **Run** dialog box, type `x:\winme\spd_stp\english\setup.exe`, where *x* is the CD-ROM or DVD-ROM drive letter.

The CD-ROM or DVD-ROM drive letter is usually *D*.



NOTE: If the driver is not in English, substitute the appropriate language.

5. Click **OK**.
6. In the **Welcome** window, click **Next>**.
7. At the **Setup Complete** window, ensure that the **Yes, I want to restart my computer now** is selected, and then click **Finish**.

Updating Drivers and Utilities

The Dell support Web site, <http://support.dell.com>, provides driver and utility updates, as well as technical assistance with questions about your computer. Dell regularly tests and releases certified drivers and utilities for Inspiron computers. In addition, if you have access to a computer with a modem and/or fax capabilities, you can access the Dell TechConnect bulletin board service (BBS), AutoTech service, and TechFax service. The Dell Web site, <http://www.dell.com>, also contains links to these services.

[Back to Contents Page](#)

[Back to Contents Page](#)

Drivers and Utilities for Microsoft® Windows® 98: Dell™ Inspiron™ 5000 Series

- [Overview](#)
 - [System Software CD](#)
 - [Installing Windows 98](#)
 - [Recreating the Hibernate \(Save-to-Disk Suspend\) File](#)
 - [Installing the Audio Driver](#)
 - [Installing the Video Driver](#)
 - [Installing the Touch Pad Driver](#)
 - [Installing Softex BayManager](#)
 - [Installing the Internal Modem Driver \(Optional\)](#)
 - [Installing the Software DVD Decoder Driver \(Optional\)](#)
 - [Installing the Intel SpeedStep Utility \(Optional\)](#)
 - [Updating Drivers and Utilities](#)
-

Overview

This section explains how to install or reinstall Dell-provided device drivers and utilities on your Dell computer running the Microsoft Windows 98 Second Edition operating system. You may need to use this information under the following conditions:

- 1 You are reinstalling the Windows operating system.
- 1 You are reinstalling the Dell-provided drivers and utilities.
- 1 You installed a new primary hard-disk drive and you must install all of the system software.

Installing Drivers and Utilities for Windows

To install the system software, you need the following items:

- 1 *System Software CD*
- 1 CD-ROM or DVD-ROM drive installed in the media bay of the computer
- 1 *Microsoft Windows 98 Second Edition CD*
- 1 *Microsoft Boot Disk Windows 98 Series* diskette



NOTES: Verify that Windows 98 is already installed on the hard-disk drive before you install any device drivers. To install Windows 98 Second Edition, see "[Installing Windows 98](#)."

The drivers on the System Software CD are the same drivers that Dell installed on your hard-disk drive before shipping the computer to you. To download the latest versions of these drivers, visit the Dell support Web site at <http://support.dell.com>.

System Software CD

The following figure shows the directory structure of the *System Software CD* for Inspiron 5000 series computers. The CD is bootable. The `R:\>` prompt appears when you exit to MS-DOS® from the **Diagnostics** menu.

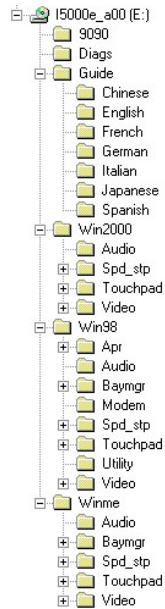

Installing Windows 98

Perform the following steps to install the Windows 98 operating system on the hard-disk drive before you install any device drivers or utilities:

1. Turn on the computer and enter the system setup program.
2. In the system setup program **Boot** menu, change the boot sequence so that the CD or DVD drive boots first. Then place the *Dell Product Recovery* CD in the CD or DVD drive and close the drive tray.
3. Exit the system setup program.
4. At the **Welcome** window, click **OK**.
5. Double-click **Refresh Windows OS**.
6. Click **OK**.
7. Click **OK** again.
8. Remove the *Dell Product Recovery* CD from the CD or DVD drive, and click **OK** to restart your computer.

The **Getting ready to run Windows for the first time** window appears.

9. If the mouse tutorial starts, press <Esc> to exit and then press <y>.
10. Click the regional setting closest to where you live, and click **Next**.
11. Click the graphic that matches your keyboard layout, and click **Next**.
12. In the **User Information** window, type your name and, if applicable, company name, and then click **Next**.

The **Name** field must be completed; the **Company Name** field is optional.

The **License Agreement** window appears.

13. Click **I accept the Agreement**, and then click **Next**.
14. Type the Windows product key in the fields provided, and then click **Next**.
The product key is the bar code number found on the Microsoft Windows label, which is located on the computer.
15. When the **Start Wizard** appears, click **Finish**.

The **Enter Windows Properties** window appears. To continue without creating a Windows user name and password, click **OK**. Otherwise, type your user name and password in the appropriate fields and then click **OK**.

16. If the **Date/Time Properties** window appears, adjust the date and time properties, click **Apply**, and then click **OK**.

Windows updates the system settings and restarts your computer.

17. If you created a Windows user name and password, type your password and click **OK**.

NOTICE: Make sure that you reinstall the Intel® Chip Set Update Utility driver *before* you reinstall any other drivers.

18. Reinstall the appropriate drivers.
 19. Reenable your virus protection software.
-

Recreating the Hibernate (Save-to-Disk Suspend) File

When the hibernate mode is activated, all system data is stored in the hibernate (save-to-disk suspend) file on your hard-disk drive. The hibernate file on your hard-disk drive cannot be accessed by the Windows operating system or application programs.

You must recreate the hibernate file if you perform any of the following actions:

- 1 Delete the hibernate file.
- 1 Install a new hard-disk drive.
- 1 Reformat your hard-disk drive.
- 1 Install additional memory.

 **NOTE:** If you install additional memory, you must delete the hibernate file before you recreate the file.

Boot Your Computer With the System Software CD

1. Save and close any open files, exit any open application programs, and shut down the computer.
2. If the computer is docked, undock it.

For instructions, see the *Port Replicator User's Guide*.
3. Turn on the computer.
4. Press <F2> when you see the Dell logo to access the system setup program.
5. Press the right-arrow key to highlight **Boot**.
6. Press the down-arrow key to highlight a device, and then press <F5> to move the device down the list or press <F6> to move the device up the list. Select the following boot sequence:
 - 1 **Floppy**
 - 1 **CD ROM/DVD**
 - 1 **Internal Hard Drive**

7. Insert the *System Software* CD into the CD-ROM or DVD-ROM drive.
8. Press <F10> to save your changes and exit the system setup program.
9. When the **Setup Confirmation** screen appears, press <Enter> to confirm that you want to save the configuration changes and exit the system setup program.

The computer restarts automatically. The Dell Diagnostics begins automatically. After the diagnostic utility loads, the **Diagnostics Menu** appears.

Fully Test All Devices Quickly Test All Devices

Select Devices to
Test
Exit to MS-DOS

10. Press the down-arrow key to select **Exit to MS-DOS** and then press <Enter>.

For instructions on deleting the hibernate file, see "Delete the Hibernate File."

Delete the Hibernate File

1. Boot your computer from the CD-ROM or DVD-ROM drive with the *System Software* CD in the CD-ROM or DVD-ROM drive.

For instructions, see "[Boot Your Computer With the System Software CD](#)."

2. At the R:\DIAGS prompt, type `cd\` and then press <Enter>.
3. At the R:\ prompt, type `cd\utility` and press <Enter>.
4. Type `phdisk /delete /file` and press <Enter>.

 **NOTE:** You must type a space between `phdisk` and `/delete` and `/file`.

5. Follow the instructions on your screen to delete the hibernate file.

The computer automatically restarts.

To create a new hibernate file immediately after deleting it, perform the following steps:

1. When the **Diagnostics Menu** appears, press the down-arrow key to select **Exit to MS-DOS** and then press <Enter>.
2. Complete steps 2 through 6 in the next section.

Create the Hibernate File

1. Boot your computer from the CD-ROM or DVD-ROM drive with the *System Software* CD in the CD-ROM or DVD-ROM drive.

For instructions, see "[Boot Your Computer With the System Software CD](#)."

2. At the R:\DIAGS prompt, type `cd\` and then press <Enter>.
3. At the R:\ prompt, type `cd\win98\utility` and press <Enter>.
4. Type `phdisk /create /file` and press <Enter>.

 **NOTE:** You must type a space between `phdisk` and `/create` and `/file`.

The utility calculates the size of the file, in kilobytes, based on the amount of system memory in your computer, plus the amount of video memory in your computer, plus 2 MB to handle additional system requirements.

5. Follow the instructions on your screen to create the hibernate file.
6. At the R:\win98\UTILITY prompt, type `phdisk /info` and press <Enter>.
7. As soon as you see the Dell logo on the screen, remove the *System Software* CD from the CD-ROM or DVD-ROM drive.

Windows automatically starts. After you create the hibernate file, you must enable hibernate support.

Enable Hibernate Support

1. Click the **Start** button, point to **Settings**, and click **Control Panel**.
2. Double-click the **Power Management** icon.
3. Click the **Hibernate** tab.

4. Ensure that **Enable hibernate support** is selected and click **Apply**.
5. Click **OK** to close the **Control Panel**.

View the Hibernate File Information

1. Boot your computer from the CD-ROM or DVD-ROM drive with the *System Software* CD in the CD-ROM or DVD-ROM drive.

For instructions, see "[Boot Your Computer With the System Software CD](#)."

2. At the `R:\DIAGS` prompt, type `cd\` and then press <Enter>.
3. At the `R:\` prompt, type `cd\utility` and press <Enter>.
4. Type `phdisk /info` and press <Enter>.

 **NOTE:** You must type a space between `phdisk` and `/info`.

The hibernate file information appears on the screen.

5. Remove the *System Software* CD from the CD-ROM or DVD-ROM drive.
 6. To restart the computer and run Windows, press <Ctrl><Alt><Delete>.
-

Installing the Audio Driver

The audio driver allows you to customize the sound features of your computer.

1. Save and close any open files, and exit any open application programs.
2. Insert the *System Software* CD into the CD-ROM or DVD-ROM drive.
3. Click the **Start** button, and then click **Run**.
4. In the **Run** dialog box, type `x:\audio\setup.exe`, where *x* is the CD-ROM or DVD-ROM drive letter.

The CD-ROM or DVD-ROM drive letter is usually *D*.

5. Click **OK**.
6. In the **Welcome** window, click **Next**>.
7. On the **Main Menu**, **Upgrade Drivers** is selected. Click **Next**>.

The audio files are copied to your hard-disk drive.

8. When prompted, ensure that **Yes, I want to restart my computer now** is selected, and then click **Finish**.

 **NOTE:** If the computer is set to boot from the CD-ROM or DVD-ROM drive before the hard-disk drive, remove the *System Software* CD before the computer restarts so that the computer does not boot from the CD. For information on changing the boot sequence, see "[System Setup Program](#)."

The **New Hardware Found** window appears, the software for the hardware is installed, and the installation is complete.

Installing the Video Driver

The video driver controls video resolution and color palette.

 **NOTE:** If you need to use extended video modes, check the documentation that accompanied the application program to determine if the driver is provided. If it is not, contact the software manufacturer for the necessary driver.

1. Save and close any open files, and exit any open application programs.

2. Insert the *System Software* CD into the CD-ROM or DVD-ROM drive.
3. Click the **Start** button, and then click **Run**.
4. In the **Run** dialog box, type `x:\video\setup.exe`, where *x* is the CD-ROM or DVD-ROM drive letter.

The CD-ROM or DVD-ROM drive letter is usually *D*.

5. In the **Setup Complete** window, ensure that **Yes, I want to restart my computer now** is selected, and then click **Finish**.

The computer restarts automatically.



NOTES: If the computer is set to boot from the CD-ROM or DVD-ROM drive before the hard-disk drive, remove the System Software CD before the computer restarts so that the computer does not boot from the CD. For information on changing the boot sequence, see "[System Setup Program](#)."

After the computer restarts, you can change the video resolution.

Installing the Touch Pad Driver

The touch pad driver controls touch pad and mouse functions.



NOTE: When you are prompted to select a directory, Dell recommends using the default directory settings.

1. Save and close any open files, and exit any open application programs.
2. Insert the *System Software* CD into the CD-ROM or DVD-ROM drive.
3. Click the **Start** button, and then click **Run**.
4. In the **Run** dialog box, type `x:\touchpad\english\setup.exe`, where *x* is the CD-ROM or DVD-ROM drive letter.

If you are using a Japanese-language version of Windows, type `x:\touchpad\japanese\setup.exe`, where *x* is the CD-ROM or DVD-ROM drive letter.

The CD-ROM or DVD-ROM drive letter is usually *D*.

NOTICE: Do not install the Japanese-language driver on a computer with a non-Japanese-language operating system.

5. Click **OK**.
6. In the **Welcome** window, click **Next>**.
7. At the **Choose Destination Location** window, click **Next>**.
8. At the **Start Copying Files** window, click **Next>**.

The touch pad drivers are copied to your hard-disk drive.

9. At the **Setup Complete** window, be sure that the **Yes, I want to restart my computer now** button is selected, and then click **Finish**.

The **Information about your Touch Pad** window appears. If you do not want this window to appear each time you start the computer, remove the check from the box that says **Show this message the next time Windows starts**. Then click **Close**.



NOTE: If the computer is set to boot from the CD-ROM or DVD-ROM drive before the hard-disk drive, remove the System Software CD before the computer restarts so that the computer does not boot from the CD. For information on changing the boot sequence, see "[System Setup Program](#)."

Installing Softex BayManager

Softex BayManager is a utility that makes it possible to swap media bay devices without turning off the computer.

NOTICE: You must uninstall Softex BayManager before you download and install a Softex BayManager software

upgrade from the Dell support Web site File Library.

To uninstall Softex BayManager, perform the following steps:

1. Save and close any open files, and exit any open application programs.
2. Click **Start**, select **Settings**, and then click **Control Panel**.
3. Double-click **Add/Remove Programs**.
4. Select **Softex BayManager** and click **Add/Remove**.
5. Follow the instructions on the screen to complete the uninstall process.

To install the Softex BayManager from the *System Software* CD, perform the following steps:

1. Insert the *System Software* CD into the CD-ROM or DVD-ROM drive.
2. Click the **Start** button, and then click **Run**.
3. In the **Run** dialog box, type `x:\baymgr\setup.exe`, where *x* is the CD-ROM or DVD-ROM drive letter.

The CD-ROM or DVD-ROM drive letter is usually *D*.

4. Click **OK**.
5. In the **Welcome** window, click **Next>**.
6. At the **Setup Complete** window, ensure that the **Yes, I want to restart my computer now** is selected, and then click **Finish**.



NOTE: If the computer is set to boot from the CD-ROM or DVD-ROM drive before the hard-disk drive, remove the System Software CD before the computer restarts so that the computer does not boot from the CD. For information on changing the boot sequence, see "[System Setup Program](#)."

Installing the Internal Modem Driver (Optional)

NOTICE: Do not use this modem driver with a PC Card modem. The modem driver on the System Software CD is compatible only with the optional internal modem.

If your computer has an internal modem, perform the following steps to install the driver:

1. Save and close any open files, and exit any open application programs.
2. Insert the *System Software* CD into the CD-ROM or DVD-ROM drive.
3. Click the **Start** button, and then click **Run**.
4. In the **Run** dialog box, type `x:\modem\setup.exe`, where *x* is the CD-ROM or DVD-ROM drive letter.

The CD-ROM or DVD-ROM drive letter is usually *D*.

5. Click **OK**.
6. In the **Welcome** window, click **Next>**.

The **New Hardware Found** window appears, the software for the modem is installed, and the installation is complete.

Installing the Software DVD Decoder Driver (Optional)

The DVD decoder driver allows you to play DVD movies using your DVD-ROM drive on the computer.



NOTE: When you are prompted to select a directory, Dell recommends that you use the default directory setting.

1. Insert the *Dell Inspiron 5000 Software DVD Decoder* CD into the DVD-ROM drive.

2. Click the **Start** button, and then click **Run**.
3. In the **Run** dialog box, type `x:\setup.exe`, where *x* is the DVD-ROM drive letter.
The DVD-ROM drive letter is usually *D*.
4. Click **OK**.
The **Welcome** window appears.
5. Click **Next>**.
6. In the **Choose Destination Location** window, click **Next>**.
7. In the **Select Program Folder** window, click **Next>**.
8. In the **Start Copying Files** window, click **Next>**.
9. In the **Setup Complete** window, ensure that the **Yes, I want to restart my computer now** is selected, and then click **Finish**.

Setting and Changing the DVD-ROM Drive Region Code

If you reinstall the DVD decoder software, you must set the DVD region code before you can play a movie. The region code can be reset if you relocate to another region.

NOTICE: You should reset the region code only when absolutely necessary. You can reset the region code up to four times.

To reset the drive region code, perform the following steps:

1. Insert a DVD movie disc coded for the new region into the DVD-ROM drive.
A notification box appears, explaining that the disc belongs to another region and cannot be played. The notification also explains how to reset the region setting.
2. Follow the instructions on the screen to change the region setting.

Installing the Intel® SpeedStep™ Utility (Optional)

NOTICE: Do not install the Intel SpeedStep utility unless your computer has a Mobile Intel Pentium® III processor with Intel SpeedStep technology. To determine if your computer has a Mobile Intel Pentium III processor with Intel SpeedStep technology, check for the Intel SpeedStep item in the Power menu of the system setup program. For instructions on using the system setup program, see "[System Setup Program](#)."

If your computer has a Mobile Intel Pentium III processor with Intel SpeedStep technology, you must reinstall the Intel SpeedStep utility after you install a new hard-disk drive or reformat your hard-disk drive.

1. Save and close any open files, and exit any open application programs.
 2. Insert the *System Software* CD into the CD-ROM or DVD-ROM drive.
 3. Click the **Start** button, and then click **Run**.
 4. In the **Run** dialog box, type `x:\spd_stp\setup.exe`, where *x* is the CD-ROM or DVD-ROM drive letter.
The CD-ROM or DVD-ROM drive letter is usually *D*.
 5. Click **OK**.
 6. In the **Welcome** window, click **Next>**.
 7. At the **Setup Complete** window, ensure that the **Yes, I want to restart my computer now** is selected, and then click **Finish**.
-

Updating Drivers and Utilities

The Dell support Web site, <http://support.dell.com>, provides driver and utility updates, as well as technical assistance with questions about your computer. Dell regularly tests and releases certified drivers and utilities for Inspiron computers. In addition, if you have access to a computer with a modem and/or fax capabilities, you can access the Dell TechConnect bulletin board service (BBS), AutoTech service, and TechFax service. The Dell Web site, <http://www.dell.com>, also contains links to these services.

[Back to Contents Page](#)

Technical Overview: Dell™ Inspiron™ 5000 Series

- [New Features](#)
 - [Hardware Overview](#)
 - [LCD Panels](#)
 - [Front View](#)
 - [Back View](#)
 - [Left Side View](#)
 - [Right Side View](#)
 - [Bottom View](#)
-

New Features

Most of the core technology implemented in the Inspiron 5000 series existed previously on other Dell portable computers. The Inspiron 5000 series has the following new key features:

- 1 A 3-spindle, 7.5-pound chassis (15-inch liquid crystal display [LCD]) with an internal diskette drive, removable hard-disk drive, and swappable media bay device.
- 1 An available Intel® Pentium®-III processor with Intel SpeedStep™ technology.
- 1 An integrated MiniPCI socket for an optional internal modem.
- 1 Microsoft® Windows® 98 Second Edition, Microsoft Windows 2000, or Microsoft Windows Millennium Edition (Me) automatically installs in Advanced Configuration and Power Interface (ACPI) mode, without any setup switches.



Hardware Overview

Processors (Inspiron 5000)	Intel Celeron™: 466 MHz, 450 MHz, and 500 MHz
	Intel Pentium III: 450 MHz and 500 MHz
	Intel Pentium III with SpeedStep technology: 600/500 MHz and 650/500 MHz
Processors (Inspiron 5000e)	Intel Celeron: 600 MHz and 650 MHz
	Intel Pentium III with SpeedStep technology: 650 MHz, 700 MHz, and 750 MHz.
System chip set	Intel 82440BX AGP Set: <ol style="list-style-type: none">1 82443BX PCI AGP controller—Integrated with the processor on the MMC-2 mobile module1 82371MB PIIX4E—Located on the system board

Memory (Inspiron 5000)	PC-100 compliant SODIMMs (SDRAM) running at: <ul style="list-style-type: none"> 1 66 MHz (Intel Celeron processor running at 466 MHz) 1 100 MHz (Intel Celeron processors running at 450 and 500 MHz, Intel Pentium III processor, and Intel Pentium III processor with Intel SpeedStep technology)
Memory (Inspiron 5000e)	PC-100 compliant SODIMMs (SDRAM) running at 100 MHz
Hard-disk drive (Inspiron 5000)	Hard-disk drive carrier provides support for 9.5-mm and 12.7-mm devices System ships with 6-GB, 12-GB, and 18-GB options
Hard-disk drive (Inspiron 5000e)	Hard-disk drive carrier provides support for 9.5-mm and 12.7-mm devices System ships with 6-GB, 10-GB, 20-GB, and 30-GB options
PC Card (CardBus)	Texas Instruments PCI-1225 CardBus controller (zoomed video supported in the lower PC Card connector)
Video (Inspiron 5000)	ATI 3D Rage Mobility-P (video RAM: 4 MB or 8 MB)
Video (Inspiron 5000e)	ATI M3 (video RAM: 8 MB or 16 MB)
Audio	ESS Maestro-2E
Super I/O controller	SMSC FDC37C958FR
Optional modem	Actiontec MP560L-MiniPCI LT WinModem Lucent L56xMF chip set
Optional NIC (APR)	Actiontec MP100I-MiniPCI 10/100 Ethernet Intel 82559 chip set



NOTE: For the full name of an abbreviation or acronym used in this table, see the Glossary in the system Help.

LCD Panels

Designator	Diagonal Measurement	Resolution
GT	14.1 inches	XGA: 1024 x 768
LT	15.0 inches	XGA: 1024 x 768
VT	15.0 inches	SXGA+: 1400 x 1050
U (Inspiron 5000e only)	15.0 inches	UXGA+: 1600 x 1200

Front View

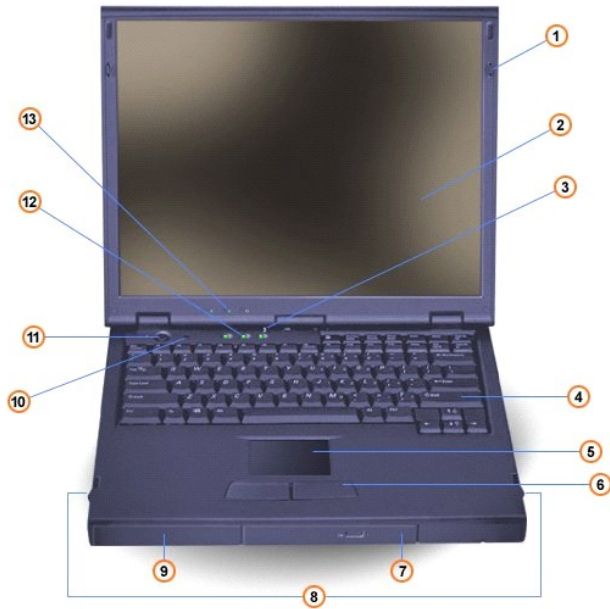

- | | |
|------------------------|------------------------------------|
| 1 Display locking tabs | 8 Display latches |
| 2 Display | 9 Battery bay |
| 3 Display-close button | 10 Microphone |
| 4 Keyboard | 11 Power button |
| 5 Touch pad | 12 Keyboard status indicators |
| 6 Touch pad buttons | 13 Device access/status indicators |
| 7 Media bay | |

Back View

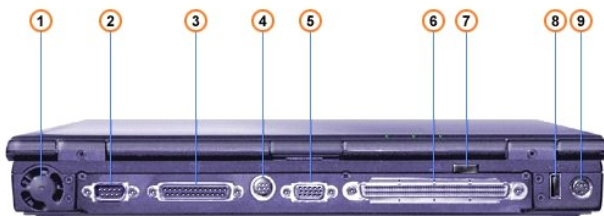

- | | |
|----------------------------|----------------------|
| 1 Fan exhaust | 6 Docking connector |
| 2 Serial port connector | 7 Infrared port |
| 3 Parallel port connector | 8 USB port connector |
| 4 TV-out S-video connector | 9 PS/2 connector |
| 5 Video connector | |

Left Side View



-
- | | |
|----------------------------|------------------------------|
| 1 Diskette drive | 4 Speaker (one of two) |
| 2 Audio connectors | 5 Display latch (one of two) |
| 3 Modem connector (option) | 6 Volume control buttons |

Right Side View



- | | |
|------------------------------|------------------------|
| 1 Security cable slot | 4 PC Card slot |
| 2 Display latch (one of two) | 5 AC adapter connector |
| 3 Speaker (one of two) | 6 Air intake |
-

Bottom View

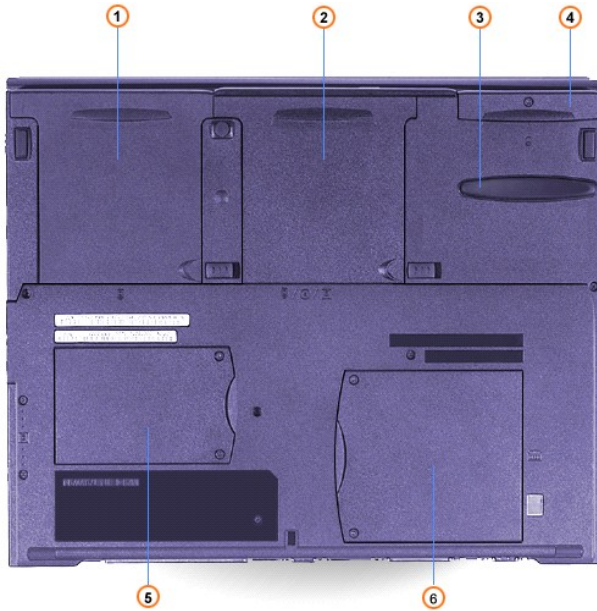

- | | |
|---------------|-----------------------|
| 1 Battery bay | 4 Hard-disk drive |
| 2 Media bay | 5 Modem cover |
| 3 Strike zone | 6 Memory module cover |
-

[Back to Contents Page](#)

Ports and Connectors: Dell™ Inspiron™ 5000 Series

- [I/O Connector Locations](#)
- [Serial Port Connector](#)
- [Parallel Port Connector](#)
- [TV-Out S-Video Connector](#)
- [Video Connector](#)
- [Infrared Port](#)
- [USB Connector](#)
- [PS/2 Connector](#)

I/O Connector Locations

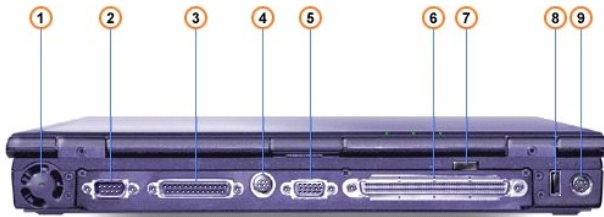

- 1 Fan exhaust
- 2 [Serial port connector](#)
- 3 [Parallel port connector](#)
- 4 [TV-out S-video connector](#)
- 5 [Video connector](#)
- 6 Docking connector
- 7 [Infrared port](#)
- 8 [USB connector](#)
- 9 [PS/2 connector](#)

Serial Port Connector

Use the 9-pin serial port connector to attach a serial device to the computer. The serial port passes data in serial format (1 bit at a time over one line). This port supports a variety of devices, including a serial mouse, that require serial data transmission. If you reconfigure your hardware, you may need pin number and signal information for the serial port connector.

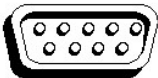

- 1 2 3 4 5
- 6 7 8 9

Pin	Signal	I/O	Definition
1	DCD	I	Data carrier detect
2	RXDA	I	Receive data
3	TXDA	O	Transmit data
4	DTR	O	Data terminal ready
5	GND	N/A	Signal ground
6	DSR	I	Data set ready
7	RTS	O	Request to send

8	CTS	I	Clear to send
9	RI	I	Ring indicator
Shell	N/A	N/A	Frame ground

Parallel Port Connector

Use the 25-hole parallel port connector to attach a parallel device to the computer. The parallel port connector is used primarily for printers. The parallel port transmits data in parallel format, where 8 data bits (one byte) are sent simultaneously over eight separate lines.

The parallel port can also be configured for compatibility with the Personal System/2 (PS/2) standard. Support for the Enhanced Parallel Port (EPP) feature improves network adapter performance (adapters connect to the computer's parallel port and require the appropriate software drivers from the adapter's manufacturer).

If you reconfigure your hardware, you may need pin number and signal information for the parallel port connector.



13 12 11 10 9 8 7 6 5 4 3 2 1
25 24 23 22 21 20 19 18 17 16 15 14

Pin	Signal	I/O	Definition
1	STB#	I/O	Strobe
2	D0	I/O	Printer data bit 0
3	PD1	I/O	Printer data bit 1
4	PD2	I/O	Printer data bit 2
5	PD3	I/O	Printer data bit 3
6	PD4	I/O	Printer data bit 4
7	PD5	I/O	Printer data bit 5
8	PD6	I/O	Printer data bit 6
9	PD7	I/O	Printer data bit 7
10	ACK#	I	Acknowledge
11	BUSY	I	Busy
12	PE	I	Paper end
13	SLCT	I	Select
14	AFD#	O	Automatic feed
15	ERR#	I	Error
16	INIT#	O	Initialize printer
17	SLIN#	O	Select in
18–25	N/A	N/A	Signal ground
Shell	N/A	N/A	Frame ground

TV-Out S-Video Connector

If the television has an S-video cable, plug it directly into the computer at the TV-out S-video connector. If the television has a composite cable, perform the following steps:

1. Connect the cable that came with your computer to the TV-out S-video connector.
2. Connect the other end of the cable to the television composite cable.

Video Connector

Use the 15-pin video connector to attach an external monitor to the computer. If the image does not appear on the monitor immediately, press <Fn><F8>.

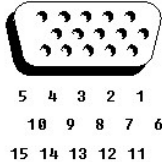



Pin	Signal	I/O	Definition
1	RED	O	Red video
2	GREEN	O	Green video
3	BLUE	O	Blue video
4	DDC2_MONID2	I	Monitor detect ID2
5	GND	N/A	Signal ground
6	GND	N/A	Signal ground
7	GND	N/A	Signal ground
8	GND	N/A	Signal ground
9	CRTVCC	O	5-V power source for CRT
10	GND	N/A	Signal ground
11	M-SEN#	I	Digital monitor sense/monitor detect ID1
12	DDC_DATA	I	Monitor detect serial data
13	HSYNC	O	Horizontal synchronization
14	VSYSN	O	Vertical synchronization
15	DDC_CLK	I	Monitor detect serial clock
Shell	N/A	N/A	Frame ground

Infrared Port

The infrared port is IrDA 1.1-compliant. An infrared data stream is transmitted through a lens in the computer, up to a distance of 1 meter (m), and received by a compatible computer, printer, mouse, or remote control. The infrared port allows the transfer of files from one computer to another infrared-compatible device, without using cable connections. Dell has installed data communications software for you to use with the infrared port. You can also use other commercially available infrared-capable application programs. For information on configuring the standard infrared drivers that come with Microsoft® Windows® 98, see your operating system documentation. To install the fast infrared drivers provided by Dell, see the instructions in the **readme.doc** file on your *System Software* CD. If for some reason you need to change the infrared port address, be careful not to create a conflict with the addresses of the serial port or the parallel port.

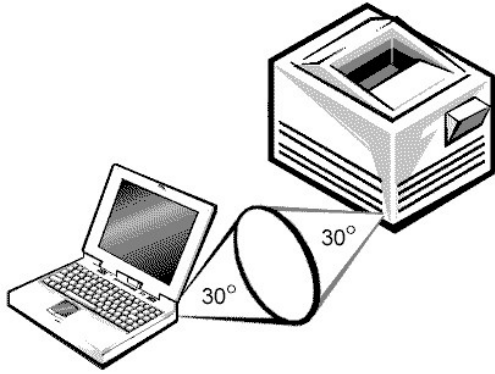
To use the infrared port, point the infrared port directly at the infrared port of the compatible device. Infrared devices transmit data in a 30° cone of infrared light. Start the data communications software on both devices, and then begin transferring files. Read the documentation that came with your compatible device to make sure you operate it correctly.



 **NOTE:** Make sure that no books, papers, or other objects block the transmission of data between the two infrared devices and that the two devices are within the 30° cone.

USB Connector

Use the Universal Serial Bus (USB) connector to attach one or more USB devices, such as a mouse, to the computer. USB is a peripheral bus standard that enables automatic detection of USB-compliant peripheral devices.



Pin	Signal	Definition
1	VCC	Cable power
2	-Data	N/A
3	+Data	N/A
4	Ground	Cable ground

PS/2 Connector

Use the 6-hole, miniature Deutsche Industrie Norm (DIN) PS/2 connector to attach PS/2-compatible devices such as a mouse, keyboard, or external numeric keypad. If you reconfigure your hardware, you may need pin number and signal information for the PS/2 connector.

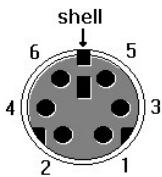

Pin	Signal	I/O	Definition
1	EXK_MSDATA	I/O	External keyboard/keypad/mouse data
2	KBD_DATA	I	Keyboard data
3	GND	N/A	Signal ground
4	EXK_MSPWR	N/A	External keyboard/keypad/mouse supply voltage
5	EXK_MSCLK	I/O	External keyboard/keypad/mouse clock
6	KBD_CLK	I	Keyboard clock

Shell	N/A	N/A	Chassis ground
-------	-----	-----	----------------

[Back to Contents Page](#)

Conserving Power: Dell™ Inspiron™ 5000 Series

- [Conservation Tips](#)
 - [Power Conservation Modes](#)
 - [Power Options Properties](#)
-

Conservation Tips

- 1 You automatically conserve battery power each time you attach your computer to an electrical outlet. When the AC adapter is attached, the battery is charged while the computer uses AC power. Your battery's life expectancy is largely determined by the number of times it is charged, so use an AC power source to run the computer if one is available.
 - 1 When the computer is using battery power, remove PC Cards that you are not using.
 - 1 When possible, attach your computer to an electrical outlet when you play CDs and DVDs. Playing a CD or DVD uses a lot of battery power.
 - 1 Place the computer in standby mode or hibernate mode when you leave the computer unattended for long periods of time. See "[Power Conservation Modes](#)" for more information.
 - 1 If you are going to connect your computer to a port replicator, click **None** when you program the display-close option on the [Advanced tab](#) in the Microsoft® Windows® **Power Options Properties** window.
 - 1 To exit a power conservation mode, press the power button.
-

Power Conservation Modes

You can use both [standby mode](#) and [hibernate mode](#) on your computer.

Standby Mode

Standby mode conserves power by turning off the display and the hard drive after a predetermined period of inactivity (a time-out.) When the computer exits standby mode, the desktop is restored to the same state that it was in before the computer entered standby mode.

To activate standby mode:

- 1 Click the **Start** button, click **Shut Down**, click **Stand by**, and then click **OK**.

or

- 1 Press the power button or the power conservation key combination, , that you programmed (via the [Advanced tab](#)).

For more information on activating standby mode for your operating system, see "Turning Your Computer On and Off" in the *Tell Me How* help file. To exit standby mode, press the power button.

 **NOTE:** You can use the [Advanced tab](#) to program the display-close option, the power button, and the power conservation key combination to activate standby mode.

NOTICE: If your computer loses AC or battery power while in standby mode, you may lose data.

Hibernate Mode

Hibernate mode conserves power by copying system data to a reserved area on the hard drive and then completely turning off the computer. When the computer exits hibernate mode, the programs and files that were open before you activated hibernate mode are still open.

Your computer enters hibernate mode if the battery charge level becomes critically low, or if either the power button, the power conservation key combination, , or the display-close option are programmed to activate hibernate mode in the [Advanced tab](#) of the **Power Options Properties** window.

To exit hibernate mode, press the power button. The computer may take a short time to return to its typical operating state.

 **NOTE:** Pressing a key or touching the touch pad will not bring the computer out of hibernate mode.

 **NOTE:** Some PC Cards may not operate correctly after resuming operation from hibernate mode. If you encounter problems with a PC Card, see "Using PC Cards" in the Tell Me How help file for instructions on removing and replacing the card, or simply restart (reboot) your computer.

Power Options Properties

To access the **Power Options Properties** window:

1. Click the **Start** button, point to **Settings**, and double-click **Control Panel**.
2. Double-click the **Power Options** icon.

Power Schemes Tab

The **Power schemes** pulldown menu displays the selected preset power scheme:

- 1 **Portable/Laptop** (default)
- 1 **Home/Office**
- 1 **Always On**
- 1 **Presentation** (Windows 2000 only)
- 1 **Minimal Power Management** (Windows 2000 only)
- 1 **Max Battery** (Windows 2000 only)

Each preset power scheme has different time-out settings for putting the computer into standby mode, turning off the monitor (display), and turning off the hard drive.

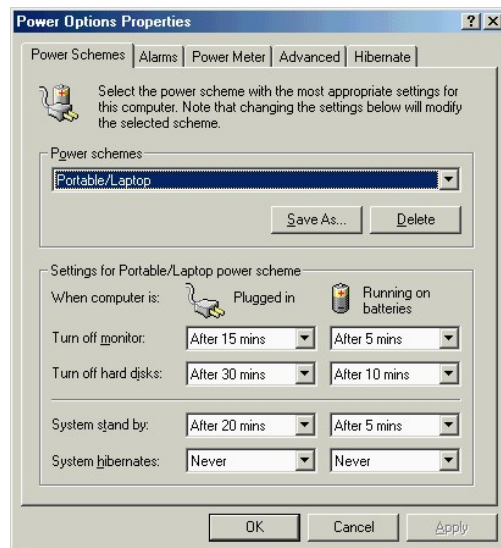



 **NOTE:** Dell recommends that you continue to use the **Portable/Laptop** power scheme to maximize battery power conservation.

Alarms Tab

The **Low battery alarm** and **Critical battery alarm** settings alert you with a message when the battery charge falls below a certain percentage. When you receive your computer, the **Low battery alarm** and **Critical battery alarm** check boxes are selected. Dell recommends that you continue to use these defaults.

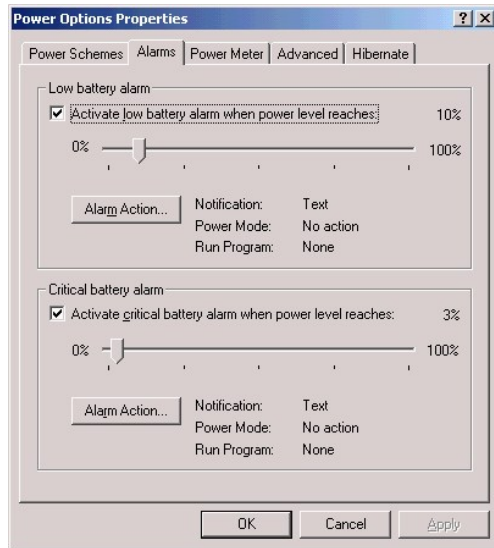
 **NOTE:** To enable audible alarms, click each **Alarm Action** button and select **Sound alarm**.



 **NOTE:** The **Critical battery alarm** setting will not function if **Power Mode** is set for **Standby** in the **Low battery alarm** setting.

Power Meter Tab

The **Power Meter** tab displays the current power source and amount of battery charge remaining.

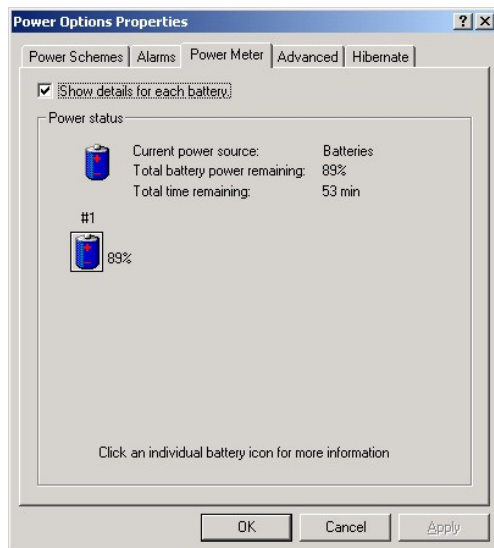

Advanced Tab

The **Advanced** tab allows you to:

- 1 Set icon and standby password options.
- 1 Program the following functions:
 - Activate [standby mode](#) (default when you close the display).
 - Activate [hibernate mode](#) (default for power button).

— Shut down Windows and turn off the computer.

— No action (None).

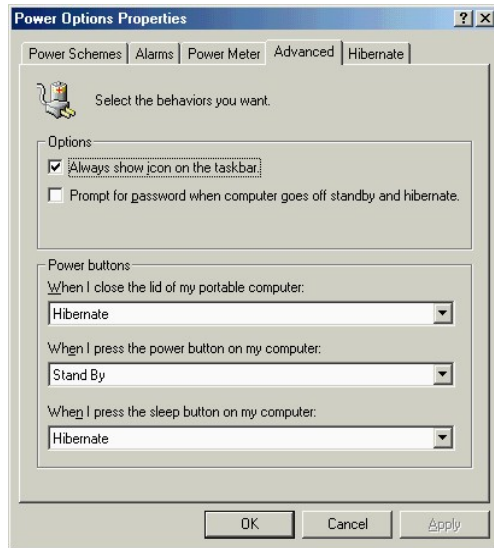

To program these functions, click an option from the corresponding pull-down menu, and then click **OK**.

 **NOTE:** If you are going to connect your computer to a port replicator, click **None** when you program the display-close option. This setting ensures that your computer does not enter standby mode or hibernate mode when you close (lower) the display.

Hibernate Tab

The **Hibernate** tab lets you enable hibernate mode by clicking the **Enable hibernate support** check box.

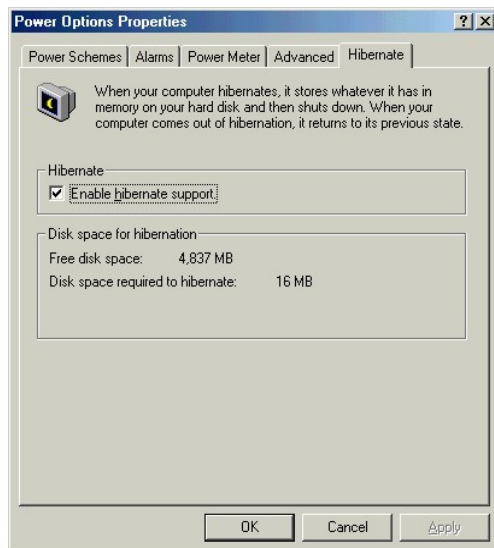

Intel® SpeedStep™ Tab

If your computer has a Mobile Intel® Pentium III processor, the **Power Options Properties** window includes the **Intel® SpeedStep™** tab.

To change the Intel SpeedStep options, click the **Advanced** button and then click one of the following options:

- 1 **Disable Intel SpeedStep technology control**

 *NOTE: If you disable Intel SpeedStep, the processor always operates at its maximum speed.*

1 **Remove flag icon**

1 **Disable audio notification when performance changes**

Click **Apply** to accept any changes, and then click **OK** to close the **Intel SpeedStep technology** window.

[Back to Contents Page](#)

[Back to Contents Page](#)

Removing and Replacing Parts: Dell™ Inspiron™ 5000 Series

Click [here](#) to view a printable (.pdf) version of the disassembly instructions.

NOTICE: Only a certified service technician should perform repairs on your computer. Damage or inoperability due to servicing not authorized by Dell is not covered by your warranty.

- [Overview](#)
 - [Precautionary Measures](#)
 - [Recommended Tools](#)
 - [Customer-Accessible Components](#)
 - [Screw Counts and Locations](#)
 - [ZIF Connectors](#)
 - [Modem Removal](#)
 - [Hinge Cover Removal](#)
 - [Keyboard Removal](#)
 - [Thermal Shield Removal](#)
 - [Processor Module Removal](#)
 - [LCD Removal](#)
 - [Video Board Removal](#)
 - [Diskette Drive Removal](#)
 - [Palmrest Removal](#)
 - [Speaker and Volume Board Removal](#)
 - [Support Rail Removal](#)
 - [Infrared Board Removal](#)
 - [System Board Removal](#)
 - [14.1-Inch XGA Display Disassembly](#)
 - [15-Inch UXGA, XGA, and SXGA+ Display Disassembly](#)
-

Overview

Unless otherwise noted, each procedure assumes the following:

- 1 You have the recommended tools.
 - 1 You have performed the steps in [Precautionary Measures](#).
 - 1 The computer and any attached peripherals are turned off and the peripherals are disconnected from the input/output (I/O) panel.
 - 1 You can replace or reinstall a part by performing the removal procedure in reverse order unless additional information is provided.
-

Precautionary Measures

NOTICE: Only a certified service technician should perform repairs on your computer. Damage or inoperability due to servicing not authorized by Dell is not covered by your warranty.

WARNING: FOR YOUR PERSONAL SAFETY AND PROTECTION OF THE EQUIPMENT:

Before you start to work on the computer, perform the following steps in the sequence indicated:

1. Ground yourself by attaching an antistatic grounding strap to your wrist and to an unpainted metal surface on the computer I/O panel. If an antistatic grounding strap is not available, periodically discharge static electricity from your body by touching one of the connectors on the I/O panel.
2. Turn off the computer and any attached peripherals.

3. Disconnect the computer and any attached peripherals from electrical outlets to reduce the potential for personal injury or shock.
-

Recommended Tools

NOTICE: Only a certified service technician should perform repairs on your computer. Damage or inoperability due to servicing not authorized by Dell is not covered by your warranty.

Most of the procedures require the use of one or more of the following tools:

- 1 Small flat-blade screwdriver
- 1 Number 1 Phillips-head screwdriver
- 1 Antistatic grounding strap
- 1 Dental pick
- 1 Small scribe or nylon flat blade
- 1 Nut drivers (5 mm and 5.5 mm)

Be careful not to scratch the computer plastic case by allowing screws to get between the work surface and the plastic case. Dell suggests a soft padded work surface.

NOTICE: The correct-length screw must be used when reinstalling a screw. Otherwise, hardware damage could result. Make sure that the screw is properly aligned with its corresponding hole, and avoid excessive tightening.

NOTICE: During the removal and replacement procedures, you will see Kapton tape (grounding tape) in many places on the computer. When reinstalling or replacing parts, be sure to replace the Kapton tape correctly to retain the electrical protection and noise reduction the tape provides.

Customer-Accessible Components

NOTICE: The steps in this section may be performed by customers.

1. Disconnect the AC adapter cable from the computer.



2. If the computer is connected to a port replicator, pull both release handles on the sides of the replicator to undock the computer.



3. Remove the battery from the battery bay:

- a. Close the display and turn the computer upside-down.
- b. Slide and hold the battery bay latch away from the battery.

The battery bay latch is located between the battery bay and the media bay.

- c. Pull the battery out of the bay.

NOTICE: Use the PC Card configuration utility on the taskbar to select and stop a card before removing it from the computer. If you do not remove the card in the configuration utility, you could lose data from open application programs.

4. Remove any PC Cards:

- a. Press the eject button.
- b. When the button slides out, press it again to release the card.
- c. Gently remove the card.
- d. Press the eject button once more until it is flush with the computer casing.

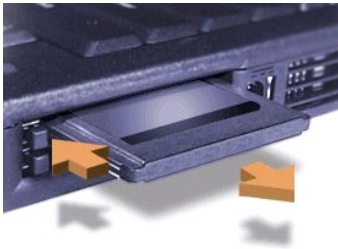

5.

Remove the hard-disk drive assembly:

- a. Turn the computer upside-down.
- b. Remove the screw securing the hard-disk drive cover.
- c. Pull the hard-disk drive carrier out of the computer.

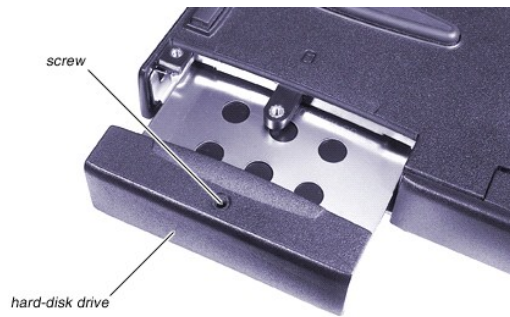

NOTICE: When the hard-disk drive is not in the computer, store it in a hard-disk drive case or protective wrapping to protect it from exposure to static electricity.

NOTICE: Handle the hard-disk drive gently; do not bump or drop the drive. Rough handling of the drive could induce failure or loss of data.

6. Remove the memory module cover:

- a. Turn the computer upside-down.
- b. Remove the two screws from the memory module cover (the larger cover).
- c. Slide the memory module cover as far as it will go towards the middle of the computer, and then remove the cover.

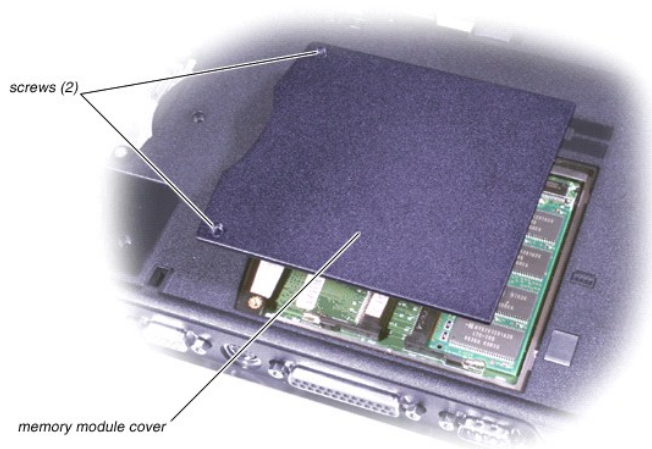

7. Remove the memory modules:

- a. Push the release tabs on either side of the memory module away from the module.
- b. The module will pop up at an angle.
- c. Pull the module from its socket.

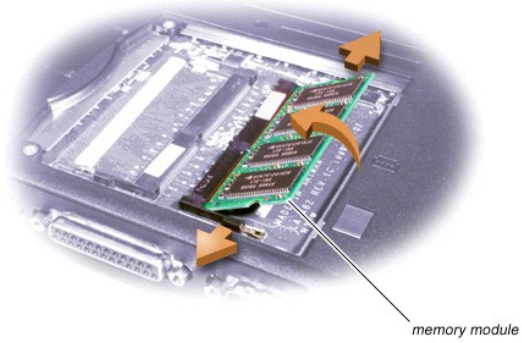

8. Remove the device from the media bay:
 - a. Close the display and turn the computer upside-down.
 - b. Slide and hold the latch release away from the media bay device.
 - c. Pull the device out of the media bay.

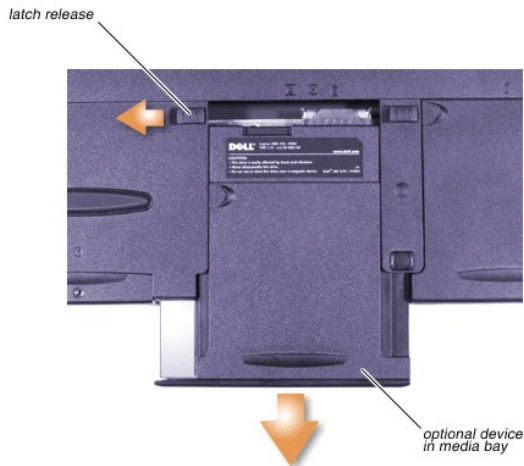

Screw Counts and Locations

NOTICE: Only a certified service technician should perform repairs on your computer. Damage or inoperability due to servicing not authorized by Dell is not covered by your warranty.

You may find it helpful to print the following table to use for keeping the screws organized as you disassemble the computer. The table lists the components from right to left in the order that they are to be removed from the computer.

Hard-Disk Drive 1	Memory 2	Modem 2
Hinge Covers 2 <i>(piece across top of keyboard)</i>	Keyboard 2 (from top)	Thermal Shield 4 (silver) for Inspiron 5000 5 (silver) for Inspiron 5000e <i>(Remove the diskette-drive-cable retaining bracket before removing the thermal shield.)</i>

Processor Module 3 for Inspiron 5000 2 for Inspiron 5000e	LCD Hinges 4 (2 per hinge)	Video Board 1 (silver)
Diskette Drive 2 (bottom of system)	Palmrest 3 (from the top) 4 (bottom of media bay) 5 (bottom of battery bay) 3 (bottom of hard-disk drive bay) 5 (deep wells in base)	Speakers and Volume Board 9 (do not unscrew the speakers) <i>(including both speakers and the volume board)</i>
Support Rail 7 (back of computer) 4 (through top of support rail) <i>(including the fan and the plastic strip)</i>	Infrared Board No screws	System Board 2 (serial port nuts) 2 (parallel port nuts) 2 (VGA port nuts) 2 (APR/PPR port nuts) 2 (screws into base)
15-Inch Display LCD Bezel 2	15-Inch Display LCD Panel 8 (4 per side)	15-Inch Display LCD Locking Tabs 4 (2 each)
14.1-Inch Display LCD Bezel 4	14.1-Inch Display LCD Panel 6 (3 per side)	14.1-Inch Display LCD Locking Tabs 4 (2 each)
LED/Inverter Board 2		

ZIF Connectors

NOTICE: ZIF connectors are fragile. To avoid breaking the connectors, touch them carefully. Do not apply too much pressure to the movable part of the connector when opening or closing it.

Some of the interface connectors are zero insertion force (ZIF) connectors. These connectors are not removable; they must be released to disconnect a cable from them.

To disconnect a cable from a ZIF connector, perform the following steps:

1. Insert a small flat-blade screwdriver, dental pick, or fingernail under the movable part of the connector.
2. Pull up gently on the movable part of the connector until the cable is released.

Some ZIF connectors may need to be lifted in the center.

3. Grasp the cable and pull it out of the connector.

To reconnect an interface cable to a ZIF connector, perform the following steps:

1. Open the ZIF connector.
2. Insert the end of the cable into the connector.
3. While holding the cable in place, close the ZIF connector.

To ensure a firm connection, make sure the ZIF connector is completely closed.

Modem Removal

NOTICE: Only a certified service technician should perform repairs on your computer. Damage or inoperability due to servicing not authorized by Dell is not covered by your warranty.

Ensure that all [precautionary measures](#) have been followed and that all [customer-accessible](#) parts are removed.

1. Remove the modem cover.
2. Spread the release tabs on either side of the modem away from the modem.
3. Remove the modem.
4. Remove the modem cable.



To reinsert the modem when you reassemble the computer, perform the following steps:

1. Attach the modem cable.
2. Insert the modem into the socket, and rock it up and down until it is completely in place.

NOTICE: Fold the modem cable out of the way of the modem door to make sure you do not cut it when you close the modem door.

Hinge Cover Removal

NOTICE: Only a certified service technician should perform repairs on your computer. Damage or inoperability due to servicing not authorized by Dell is not covered by your warranty.

1. Remove the hinge cover screws.

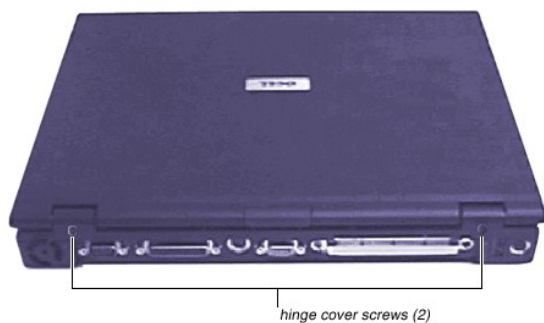

2. Open the display, and lift off the hinge cover by rotating it toward you.

To replace the hinge cover, perform the following steps:

1. Insert the hinge cover at a 45° angle.
2. Press the hinge cover down above the <F4>, <F5>, and <Print Screen> keys.
3. Press down along the entire length of the hinge cover until it fits securely in place.
4. Replace the screws.



Keyboard Removal

NOTICE: Only a certified service technician should perform repairs on your computer. Damage or inoperability due to servicing not authorized by Dell is not covered by your warranty.

1. Remove the screws.
2. Slide the keyboard out from under the palmrest.

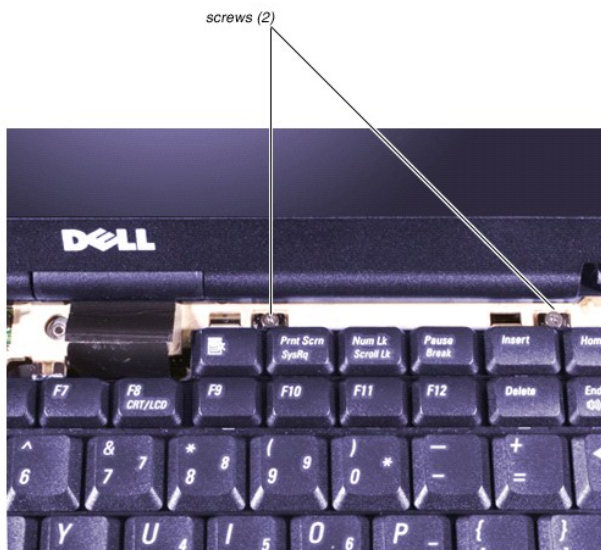

3. Detach the cable from the [ZIF connector](#).

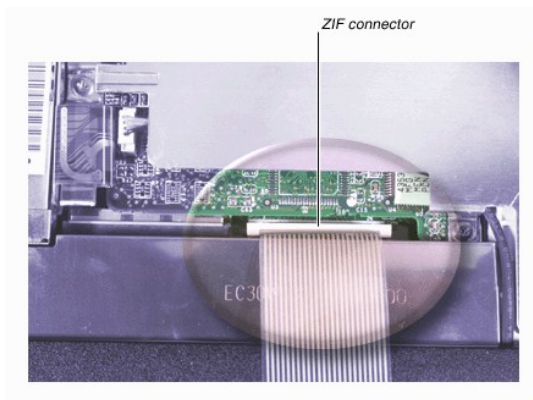

Thermal Shield Removal

NOTICE: Only a certified service technician should perform repairs on your computer. Damage or inoperability due to servicing not authorized by Dell is not covered by your warranty.

1. Remove the thermal shield screws. Inspiron 5000 computers have 4 screws (first photo), and Inspiron 5000e computers have 5 screws (second photo).

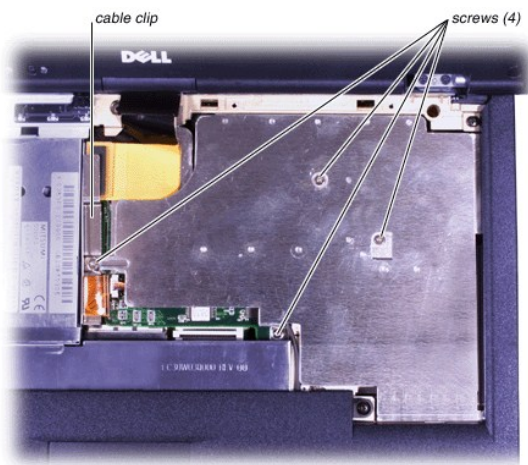

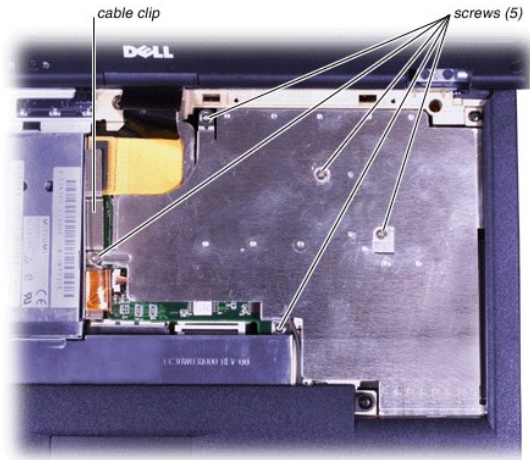

2. Remove the diskette-drive cable clip (held in place by the leftmost thermal shield screw).
3. Lift off the thermal shield.

NOTICE: Be sure to replace the diskette-drive cable clip (held in place by the leftmost thermal shield screw) when you replace the thermal shield. Failure to do so may cause the connector to become disengaged as a result of shock or vibration to the computer.

Processor Module Removal

NOTICE: Only a certified service technician should perform repairs on your computer. Damage or inoperability due to servicing not authorized by Dell is not covered by your warranty.

1. Remove the processor module screws. Inspiron 5000 computers have 3 screws (first photo), and Inspiron 5000e computers have 2 screws (second photo).

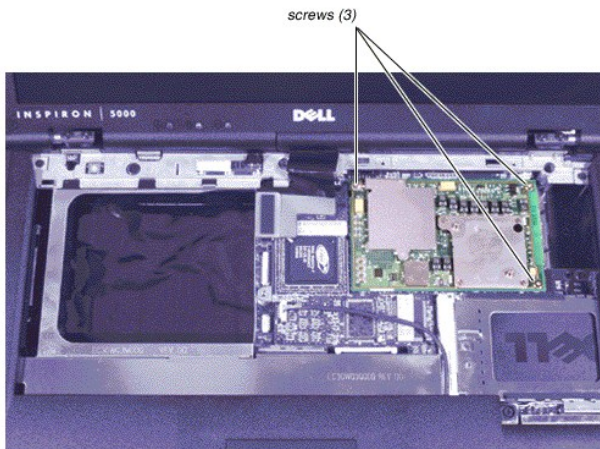

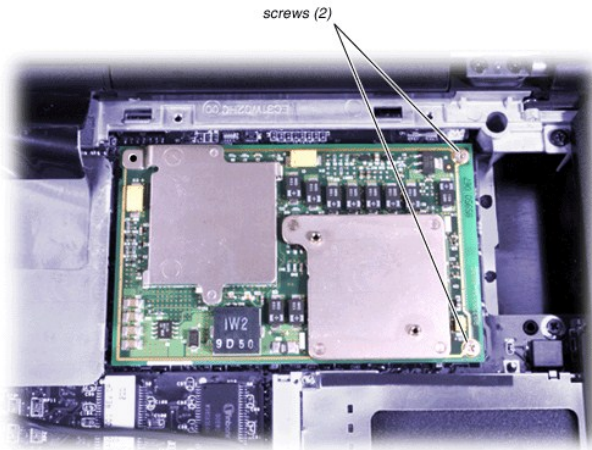

2. Lift out the module.
3. When you replace the processor, be sure to attach it to the connector.

When you replace the processor during reassembly, be sure to attach it to the connector.

LCD Removal

NOTICE: Only a certified service technician should perform repairs on your computer. Damage or inoperability due to servicing not authorized by Dell is not covered by your warranty.

1. Open the display and disconnect the LCD flex cable.
2. Close the display and remove the four LCD hinge screws.

NOTICE: Route the cable under the cable clip on computers that have extended cable clips so that the LCD flex cable will stay connected to the system board.

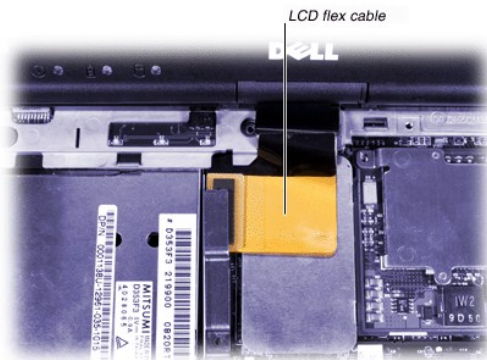

Video Board Removal

NOTICE: Only a certified service technician should perform repairs on your computer. Damage or inoperability due to servicing not authorized by Dell is not covered by your warranty.

1. Remove the screw.
2. Disconnect the touch pad cable.

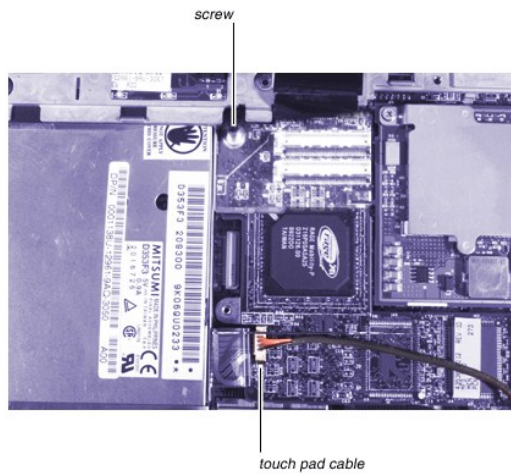

Diskette Drive Removal

NOTICE: Only a certified service technician should perform repairs on your computer. Damage or inoperability due to servicing not authorized by Dell is not covered by your warranty.

1. Detach the data cable.

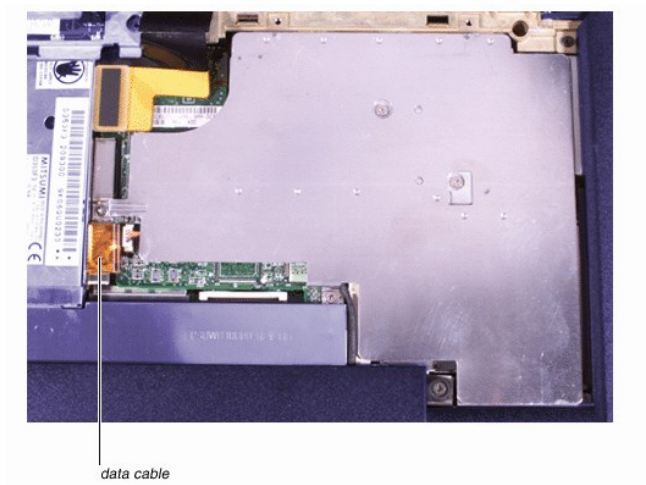

2. Remove the drive retaining screws from the bottom of the computer.

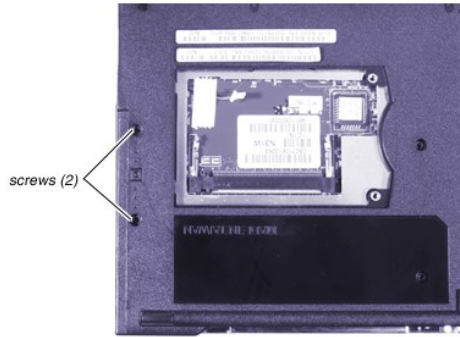

3. Remove the drive from the chassis.

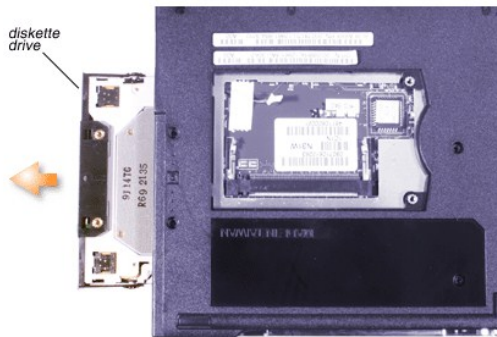

Palmrest Removal

NOTICE: Only a certified service technician should perform repairs on your computer. Damage or inoperability due to servicing not authorized by Dell is not covered by your warranty.

1. Remove the three screws from the top of the computer.

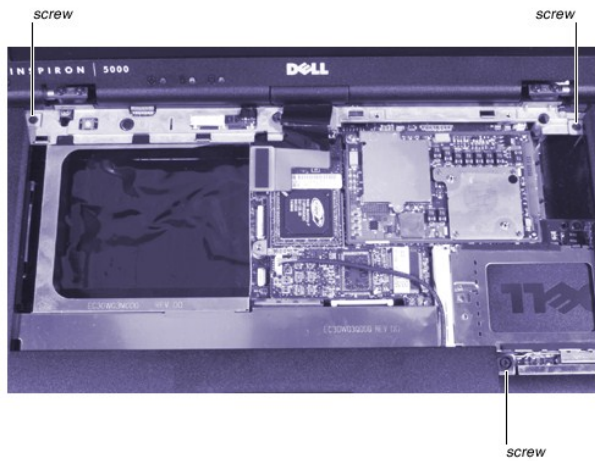

2. Remove the two screws (outer corners) from the bottom of the computer.

If you plan to remove the system board, also remove the three screws adjacent to the memory module slots and the modem.

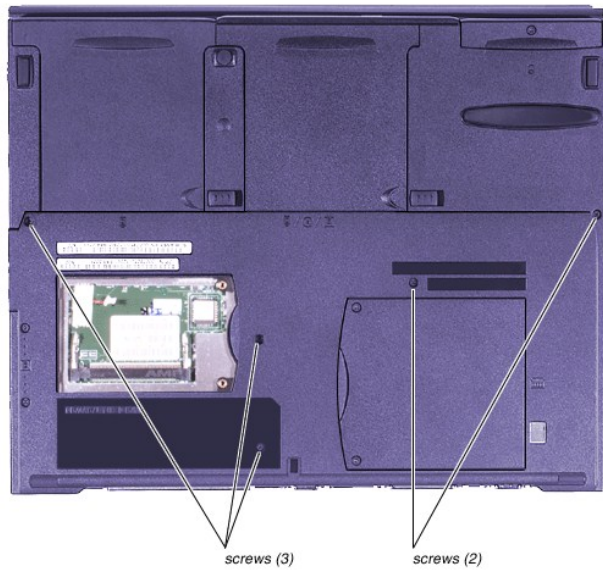

3. Remove the three screws from the hard-disk drive compartment.

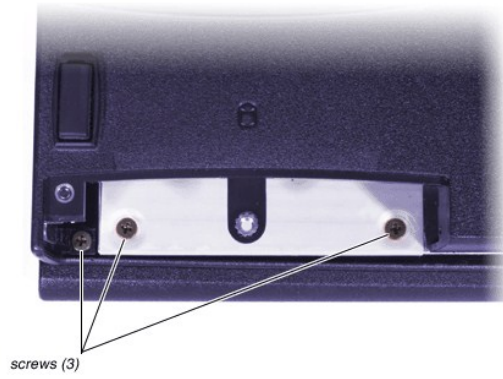

4. Remove the four screws from the battery bay.

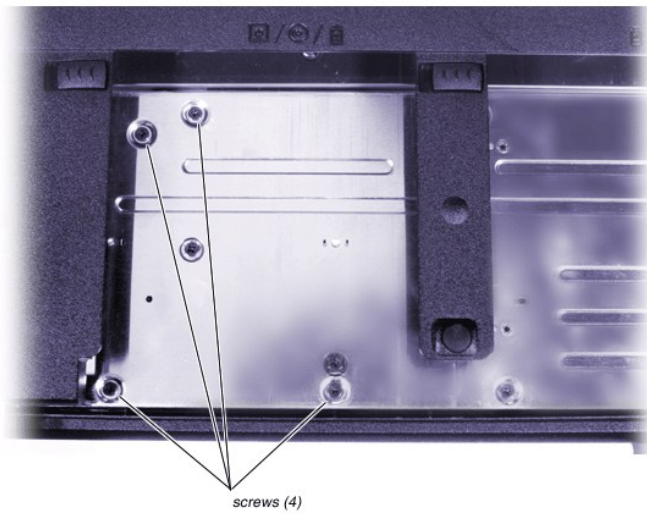

5. Remove the five screws from the media bay.

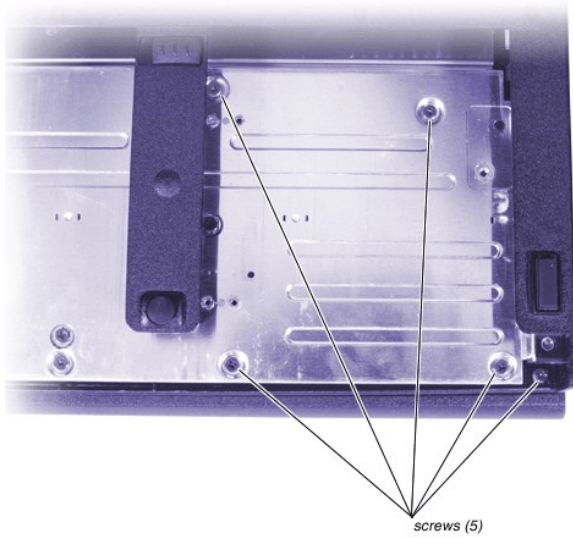

Speaker and Volume Board Removal

NOTICE: Only a certified service technician should perform repairs on your computer. Damage or inoperability due to servicing not authorized by Dell is not covered by your warranty.

1. Remove the nine screws.
2. Disconnect the speaker cable. Be sure to carefully remove the Kapton tape that holds the speaker cable in position on the left side.
3. Disconnect the volume cable.

NOTICE: When you replace the speaker and volume board, be sure not to cut the modem cable.

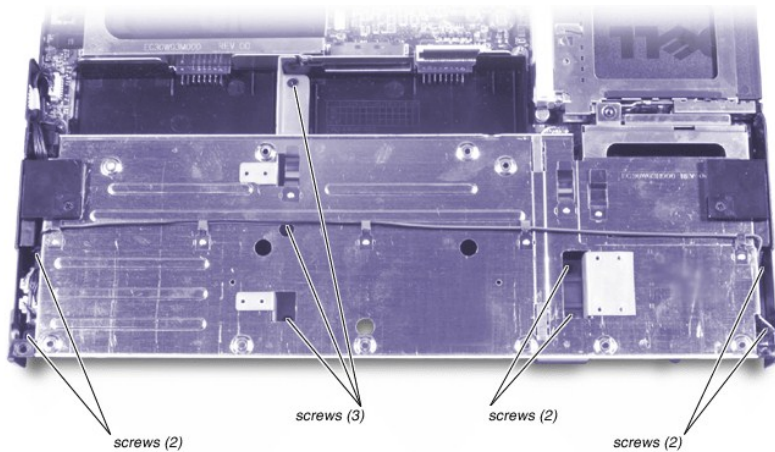

Support Rail Removal

NOTICE: Only a certified service technician should perform repairs on your computer. Damage or inoperability due to

servicing not authorized by Dell is not covered by your warranty.

1. Remove the four screws.
2. Disconnect the fan cable.

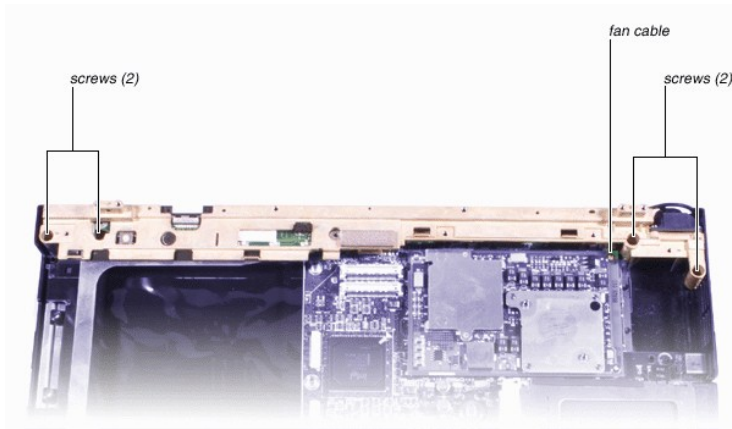

3. Remove the seven screws from the back of the computer.

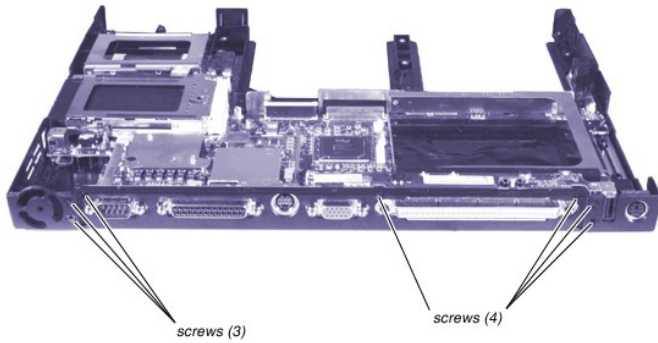

Infrared Board Removal

NOTICE: Only a certified service technician should perform repairs on your computer. Damage or inoperability due to servicing not authorized by Dell is not covered by your warranty.

Disconnect the infrared board from the system board.

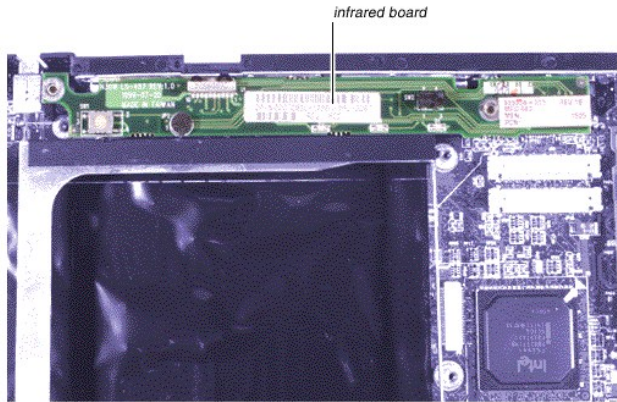

System Board Removal

NOTICE: Only a certified service technician should perform repairs on your computer. Damage or inoperability due to servicing not authorized by Dell is not covered by your warranty.

1. Remove the two screws.

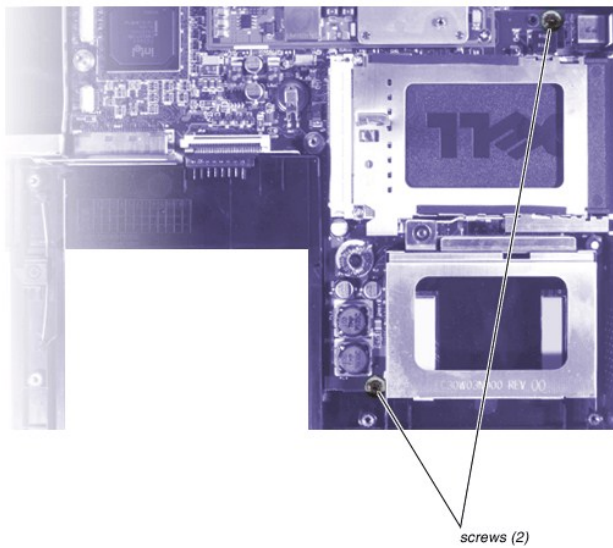

2. Remove the eight I/O port nuts.

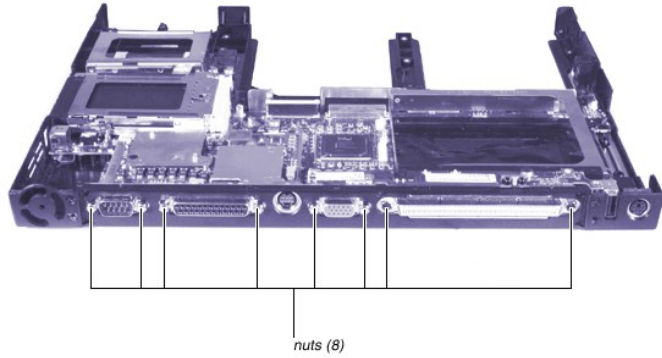

3. Flex the base plastics to separate the system board from the audio connector posts on the left side of the computer.
 4. Lift the system board up and out from the base plastics.
-

14.1-Inch XGA Display Disassembly

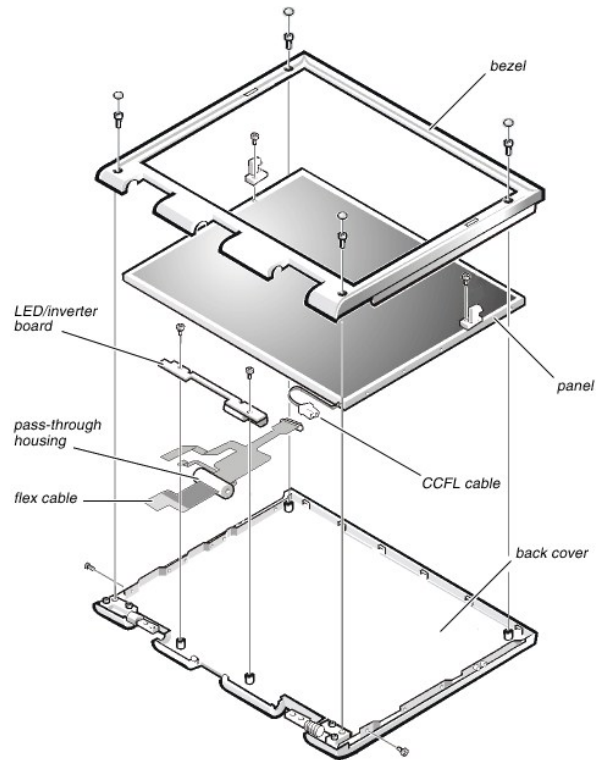

Bezel Removal

1. Remove the two screw covers from the bottom corners of the LCD bezel.
2. Remove the two bumpers from the top corners of the LCD bezel.
3. Remove the four screws from the corners of the LCD bezel.
4. Ease your fingers under the bezel on the bottom of the bezel.

Work your way around the bezel and disengage all the retaining tabs.

5. Once you have disengaged all of the retaining tabs, lift the bezel from the LCD panel.

Panel Removal

NOTICE: It is not necessary to remove the display locking tabs when removing the panel.

1. Remove the two screws from each side of the panel.
2. Disconnect the cold cathode fluorescent lamp (CCFL) cable from the bottom of the panel.
3. Disconnect the flex cable from the back of the LCD panel.
4. Lift the panel from the back cover.

LED/Inverter Board Removal

1. Remove the two screws from the LED/inverter board.
2. Disconnect the flex cable from the ZIF connector on the bottom side of the LED/inverter board.

Flex Cable Removal

1. Remove the grounding tape that secures the wire harness to the back cover.
2. Carefully snap out the flex cable pass-through housing from the back cover.
3. Ease the flex cable over to one side.
4. Insert a flat instrument into the wide opening of the pass-through housing.

Be careful not to damage the flex cable.

5. Carefully ease the cover from the pass-through housing.

15-Inch UXGA, XGA, and SXGA+ Display Disassembly

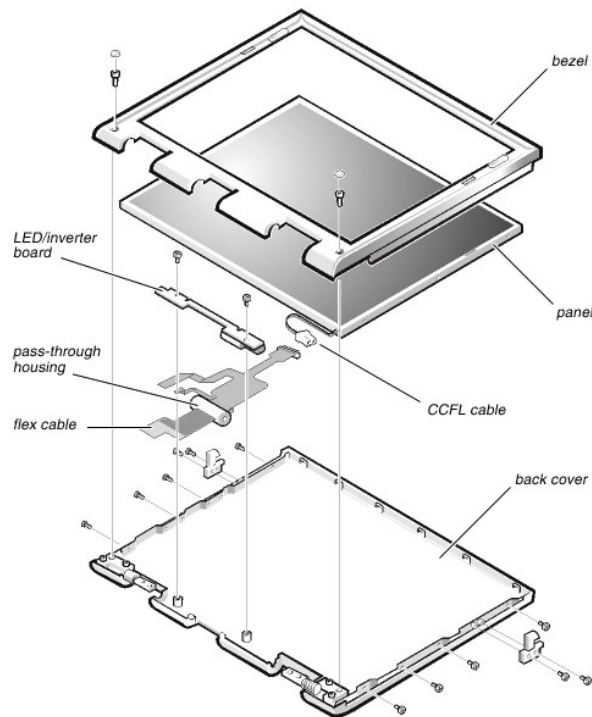

Bezel Removal

1. Remove the two screw covers from the bottom corners of the LCD bezel.
2. Remove the two screws from the bottom corners of the LCD panel.
3. Ease your fingers under the bezel at the top of the panel.
Work your way around the bezel and disengage all the retaining tabs.
4. Once you have disengaged all of the retaining tabs, lift the bezel from the LCD panel.

Panel Removal

1. Remove the two latch assembly screws from each of the two display locking tabs.
2. Remove the four screws from each side of the LCD panel.
3. Disconnect the CCFL cable from the bottom of the panel.
4. Disconnect the flex cable from the LCD panel.
5. Lift the LCD panel from the back cover.

LED/Inverter Board Removal

1. Remove the two screws from the LED/inverter board.
2. Disconnect the flex cable from the ZIF connector on the bottom side of the LED/inverter board.

Flex Cable Removal

1. Remove the grounding tape that secures the wire harness to the back cover.
2. Carefully snap out the flex cable pass-through housing from the back cover.
3. Ease the flex cable over to one side.
4. Insert a flat instrument into the wide opening of the pass-through housing.
Be careful not to damage the flex cable.
5. Carefully ease the cover from the pass-through housing.

[Back to Contents Page](#)

System Setup Program: Dell™ Inspiron™ 5000 Series

- [Using the System Setup Program](#)
 - [Security Menu](#)
 - [Accessing the System Setup Program](#)
 - [Power Menu](#)
 - [Main Menu](#)
 - [Boot Menu](#)
 - [System Devices Menu](#)
 - [Exit Menu](#)
-

Using the System Setup Program

The computer retains system configuration information in the nonvolatile random-access memory (NVRAM) maintained by the reserve battery. Each time you turn on the computer, the system compares the installed hardware with the system configuration information stored in NVRAM. If the system detects a discrepancy, it generates an error message that identifies the incorrect configuration setting.

The system setup program can be used to perform the following tasks:

- 1 Change the system configuration information after adding, changing, or removing hardware connected to or installed inside the computer.
- 1 Verify information about the current configuration, such as the amount of system memory.
- 1 Set or change selectable features—for example, power management or security features.

 **NOTE:** When the computer is running the Windows® operating system, the Windows power settings override the system setup program settings.

Accessing the System Setup Program

NOTICE: To avoid data loss, exit any application programs before rebooting the computer to enter the system setup program.

To access the system setup program, turn on the computer and press <F2> when the Dell logo appears.

The [Main](#) menu of the system setup program shows how the computer is configured. In addition to the **Main** menu, you can also access the [System Devices](#) menu, [Security](#) menu, [Power](#) menu, [Boot](#) menu, and [Exit](#) menu.

Navigating Through the System Setup Program

Use the integrated keyboard to make all selections in the system setup program.

 **NOTE:** External Universal Serial Bus (USB) keyboards only function when Windows is running.

Key	Function
<F1>	System setup program Help information appears.
up-arrow and down arrow	Highlights an item.
<F5> or <F6>	Changes the setting value.
<F9>	Selects the default settings for all settings in the system setup program.
<Esc>	Exits the system setup program without saving changes.
left-arrow and right-arrow	Highlights a menu item.
<Enter>	Highlights a submenu item (or executes a command on the Exit menu only).
<F10>	Saves changes and exits the system setup program.

Main Menu

NOTICE: Video driver settings override the Television Type setting.

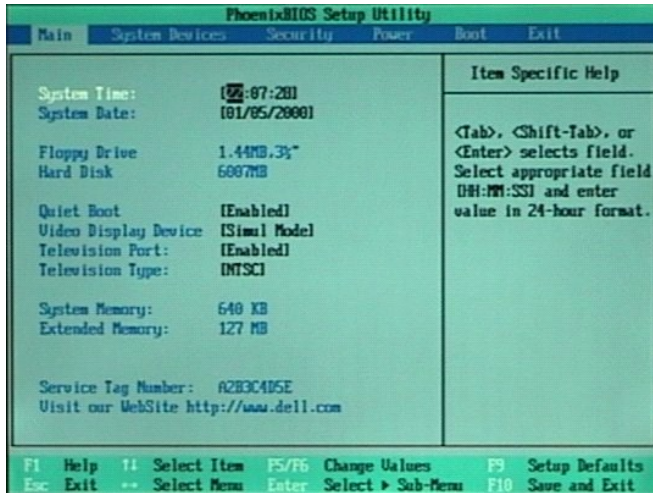

Option	Function
System Time	Resets the time on the internal clock.
System Date	Resets the date on the internal calendar.
Floppy Drive	Identifies the type of diskette drive being used by the computer. This option is not configurable.
Hard Disk	Displays the capacity of the internal hard-disk drive. This option is not configurable. <i>NOTE: If a second hard-disk drive is installed, it does not appear in this option even if installed.</i>
Quiet Boot	When set to Disabled , allows POST messages and the summary screen to appear at system start-up. When set to Enabled (default), prevents the diagnostic POST messages and summary screen from appearing at system start-up. If Quiet Boot is enabled, a boot device cannot be selected during start-up.
Video Display Device	Allows you to specify whether video is visible only on the integrated display (LCD Mode), only on an external monitor or projector (CRT Mode), or on both the display and an external device simultaneously (Simul Mode , the default). Press <Fn><F8> to change the video display device when Windows is running.
Television Port	When set to Enabled (default), allows the computer to display the screen image on a TV (if one is attached to the TV-out S-video connector) and disables the integrated display as well as an external monitor. When set to Disabled , allows the screen image to appear on the device specified in the Video Display Device option.
Television Type	Allows you to set the TV-out signal to NTSC (default) or PAL . Consult your television documentation for information on which setting you should use. NOTICE: Video driver settings override the Television Type setting.
System Memory	Displays the base amount of DRAM installed in the computer. Each computer has 640 KB of base memory. This option has no selectable settings.
Extended Memory	Displays the total amount of memory above 1 MB. Each computer comes standard with at least 32 MB of memory installed. If you install or remove memory, the amount of extended memory displayed changes. This option has no selectable settings.
System Tag Number	Also known as the system service tag sequence. This sequence is the same sequence found on the bar code label on the computer. It is used to identify the computer.

 *NOTE: For the full name of an abbreviation or acronym used in this table, see the Glossary in the system Help.*

System Devices Menu

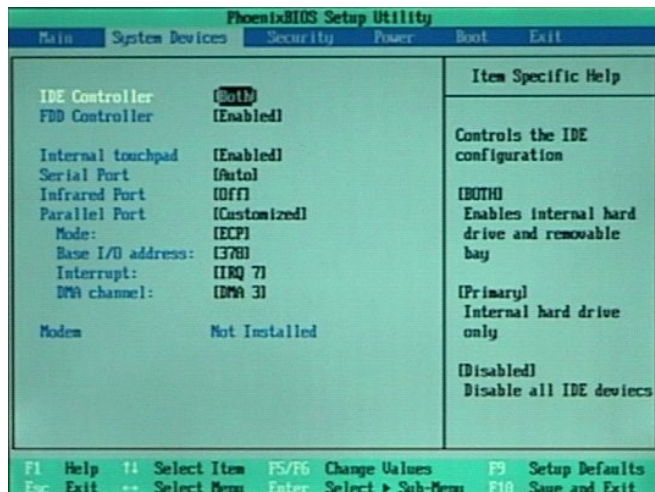

Option	Function
IDE Controller	Configures the integrated local-bus IDE adapter. Options are Both (default), Disabled , or Primary . If Both is selected, you can access both the hard-disk drive and the media bay device(s). If Primary is selected, only the hard-disk drive and megabit device is accessible. When Disabled , the media bay device(s) and hard-disk drive are disabled.
FDD Controller	Enables the diskette-drive controller. If this option is set to Disabled , the diskette drive is unavailable.
Internal touchpad	When set to Enabled (default), allows the touch pad to continue working when an external mouse or other pointing device is connected. Auto Disabled disables the touch pad when an external pointing device is connected.
Serial Port	Lets you map the address of the serial port to avoid address conflicts with other devices or disable the port for security. When set to Auto , allows the operating system or the BIOS to configure the port automatically. When set to Customized (default), sets the Base I/O address/IRQ to 3F8 IRQ4 . If there is a conflict between two or more addresses, an asterisk appears next to the port type. Off disables the serial port to conserve power.
Infrared Port	Lets you map the address of the infrared port to avoid address conflicts with other devices. The default is Off . Dell recommends that you retain the default unless you are using an infrared device with the computer. When this option is set to Customized , the Mode is SIR and the Base I/O address/IRQ is 2F8 IRQ3 . If you change the infrared port address, be careful not to create a conflict with the addresses of the serial port or the parallel port. If there is a conflict between two or more addresses, an asterisk appears next to the port type.
Parallel Port	Controls whether the parallel port acts as an AT-compatible (unidirectional), PS/2-compatible (bidirectional), EPP-compatible, or ECP-compatible port. When this option is set to Customized (default), the Mode is ECP , the Base I/O address is 378 , the Interrupt is IRQ 7 , and the DMA channel is DMA 3 . The Auto setting allows the operating system or the BIOS to configure the port automatically. When the option is set to Off , the port is disabled and you can use its assigned LPT resources for another device. If you change the parallel port address and/or DMA channel, be careful not to create a conflict with the address or DMA channel of the infrared port.
Modem	This option has no selectable settings.

 **NOTE:** For the full name of an abbreviation or acronym used in this table, see the Glossary in the system Help.

Security Menu

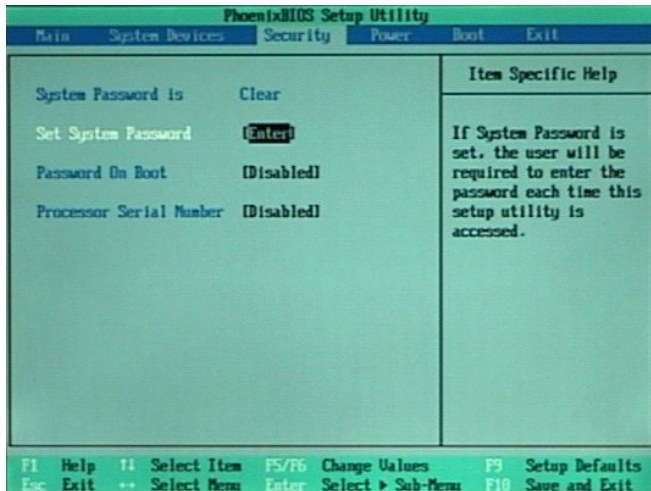

Option	Function
System Password is	If no system password is set, the setting is Clear . Otherwise, the setting is Set .
Set System Password	Press <Enter> to set up a new system password, and then follow the instructions on your screen. This password restricts access to the system setup program settings.
Password On Boot	When this option is enabled, you must enter a password before the computer loads the operating system into memory. Settings for this option are Disabled (default) and Enabled . To enable this option, the System Password option must be set.
Processor Serial Number (Intel Pentium III processor only)	Settings for this option are Disabled (default) and Enabled . If disabled, prevents the transmission of the processor serial number when connected to the Internet.

NOTE: For the full name of an abbreviation or acronym used in this table, see the Glossary in the system Help.

Power Menu

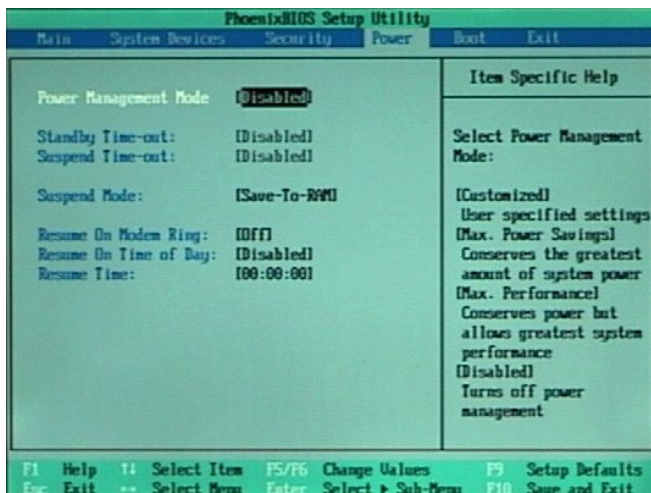

NOTE: The power settings of the Windows 98 operating system take precedence over the settings described here. For more information, see "Conserving Power" in the system Help.

Option	Function
Power Management Mode	Disabled (default) turns off power management. Customized allows you to control each power management

	setting. Max. Power Savings conserves the maximum amount of system power, and Max. Performance conserves power but allows the greatest system performance.
Standby Time-out	Lets you determine how long the computer remains idle (no I/O activity) before activating standby mode to conserve battery power. Settings for this option are Disabled (default), 1 Minute , 2 Minutes , 4 Minutes , 6 Minutes , 8 Minutes , 12 Minutes , and 16 Minutes . To increase battery operating time, set this option to a lower number of minutes. Press any key on the integrated keyboard to resume normal computer operation. <i>NOTE: Set this option to Disabled if it causes compatibility problems with your software.</i>
Suspend Time-out	Lets you determine how long the computer remains idle (no I/O activity) before activating save-to-disk suspend mode. Settings for this option are Disabled , 5 Minutes , 10 Minutes , 15 Minutes , 20 Minutes , 30 Minutes , 40 Minutes , and 60 Minutes . To increase battery operating time, set this option to a lower number of minutes. <i>NOTE: Set this option to Disabled if it causes compatibility problems with your software.</i>
Suspend Mode	When this option is set to Save to RAM (default), the computer conserves battery power by entering standby mode. In suspend mode, almost all computer activity stops, but the computer remains ready to resume operations in seconds. Resume normal computer activity by pressing the power button (the computer may take several seconds to return to normal operation). When this option is set to Save to Disk , the computer copies all system data to a reserved area on the hard-disk drive and then turns off all power to the computer. When the computer resumes normal operation, the same programs will be running and the same files will be open that were loaded before you activated this mode. Use save-to-disk suspend mode to conserve battery power or to preserve system data by quickly saving it to the hard-disk drive if you are about to run out of battery power.
Resume On Modem Ring	Setting this option to Enabled tells the computer to resume normal operation when an incoming call is detected by a modem and the computer is in standby mode. The default is Disabled . To use this option, Suspend Mode must be set to Save to RAM .
Resume On Time of Day	When the Resume On Time of Day option is set to Enabled , a computer in standby mode resumes normal operation at the time specified in the Resume Time field. The default is Disabled . To use this option, Suspend Mode must be set to Save to RAM .
Resume Time	Lets you specify a time when the computer resumes from standby mode to normal operation. To use this option, Suspend Mode must be set to Save to RAM .

 *NOTE: For the full name of an abbreviation or acronym used in this table, see the Glossary in the system Help.*

Boot Menu

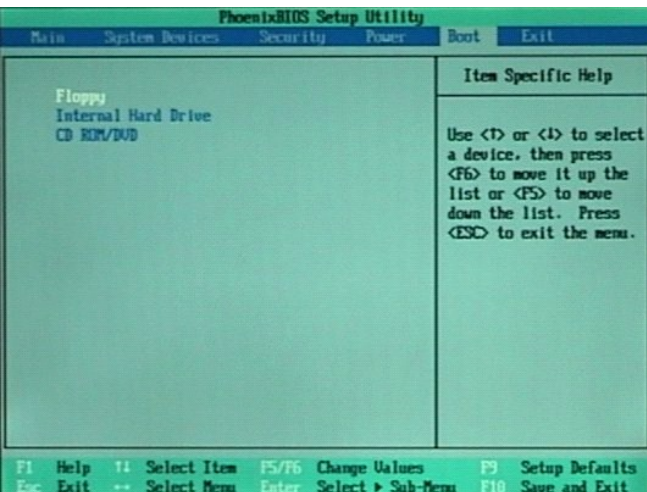

Option	Function
Floppy	The computer attempts to boot first from a bootable diskette. If it does not detect a bootable disk, the computer tries to boot from the hard-disk drive. If a disk is in the diskette drive, but does not have the required system files, an error message appears.

Internal Hard Drive	The computer boots only from the hard-disk drive. If it fails to boot from the hard-disk drive, the computer does not attempt to boot from the diskette drive.
CD-ROM/DVD	Causes the computer to attempt to boot first from a bootable CD. If it does not detect a bootable CD in the CD-ROM or DVD-ROM drive, the computer tries to boot from the hard-disk drive. If a CD is in the CD-ROM or DVD-ROM drive, but the CD does not have the required boot files, an error message appears.

 NOTE: For the full name of an abbreviation or acronym used in this table, see the Glossary in the system Help.

Exit Menu

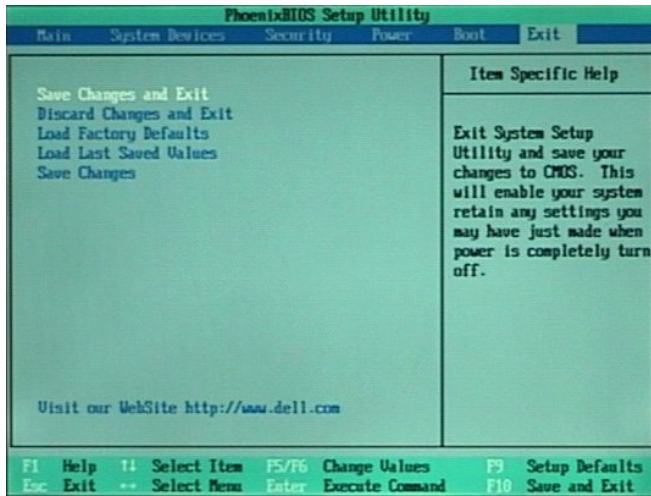

Option	Function
Save Changes and Exit	Saves any changes you have made and exits the system setup program.
Discard Changes and Exit	Discards any changes you have made and exits the system setup program.
Load Factory Defaults	Discards any changes you have made and reverts all options to their original default settings, but does not exit the system setup program.
Load Last Saved Values	Discards the settings you have made and restores the settings you previously saved. Press <Enter> when prompted to continue.
Save Changes	Saves settings without exiting the system setup program. Press <Enter> when prompted to continue, and then return to other menus to make changes.

 NOTE: For the full name of an abbreviation or acronym used in this table, see the Glossary in the system Help.

[Back to Contents Page](#)

Technical Specifications: Dell™ Inspiron™ 5000 Series

- [Microprocessor](#)
 - [Chip Set and Bus](#)
 - [PC Card Slot](#)
 - [Memory](#)
 - [Connectors](#)
 - [Integrated Audio](#)
 - [Video](#)
 - [Physical](#)
 - [Keyboard](#)
 - [Touch Pad](#)
 - [Battery](#)
 - [AC Adapter](#)
 - [Environmental](#)
 - [Regulatory](#)
-

Microprocessor

Inspiron 5000

Microprocessor type and speed:

Dell Inspiron 5000G	Intel® Mobile Pentium® III microprocessor with Intel SpeedStep™ technology running at 600/500 MHz and 650/500 MHz
Dell Inspiron 5000R	Intel Mobile Pentium III microprocessor running at 450 and 500 MHz
Dell Inspiron 5000C	Intel Celeron™ microprocessor running at 450, 466, and 500 MHz

L1 cache:

Dell Inspiron 5000G, R, and C	32 KB (internal)
-------------------------------	------------------

L2 cache:

Dell Inspiron 5000G and R	256 KB (integrated)
Dell Inspiron 5000C	128 KB (integrated)

Math coprocessor

internal to the microprocessor

Inspiron 5000e

Microprocessor type and speed:

Dell Inspiron 5000eG	Intel® Mobile Pentium® III microprocessor with Intel SpeedStep™ technology running at 600/500 MHz, 700/550 MHz, 750/600 MHz, 800/650 MHz, and 850/700 MHz
Dell Inspiron 5000eC	Intel Celeron™ microprocessor running at 500 and 600 MHz

L2 cache:

Dell Inspiron 5000eG	256 KB (integrated)
Dell Inspiron 5000eC	128 KB (integrated) (only for Celeron microprocessors)

Math coprocessor

internal to the microprocessor

Chip Set and Bus

System chip set	Intel Mobile 440BX AGP
Data bus width	64 bits
DRAM bus width	64 bits
Address bus width	32 bits
Flash EPROM	4 Mb

PC Card Slot

PCI controller	Texas Instruments PCI 1225 CardBus controller
PC Card connectors	two (supports two Type I cards, two Type II cards, or one Type III card)
Cards supported	3.3 V and 5 V
PC Card connector size	68 pins
Data width (maximum)	32 bits

Memory

Architecture	SDRAM
Memory module capacities	32-, 64-, 128-, 192-, and 256-MB SODIMM
Minimum RAM	32 MB
Maximum RAM	512 MB
Memory access time/clock frequency	66 MHz or 100 MHz
BIOS address	F000:0000

The computer can accommodate up to 512 megabytes (MB) of synchronous dynamic random-access memory (SDRAM).

Valid Memory Configurations*		
Slot 1	Slot 2	Total
32 MB	32 MB	64 MB
32 MB	64 MB	96 MB
32 MB	128 MB	160 MB
32 MB	192 MB	224 MB
32 MB	256 MB	288 MB
64 MB	32 MB	96 MB
64 MB	64 MB	128 MB
64 MB	128 MB	192 MB
64 MB	192 MB	256 MB
64 MB	256 MB	320 MB
128 MB	32 MB	160 MB
128 MB	64 MB	192 MB
128 MB	128 MB	256 MB
128 MB	192 MB	320 MB
128 MB	256 MB	384 MB
192 MB	32 MB	224 MB
192 MB	64 MB	256 MB

192 MB	128 MB	320 MB
192 MB	192 MB	384 MB
192 MB	256 MB	448 MB
256 MB	32 MB	288 MB
256 MB	64 MB	320 MB
256 MB	128 MB	384 MB
256 MB	192 MB	448 MB
256 MB	256 MB	512 MB

**Not all valid memory configurations are available at all times. Contact Dell for details.*

Upper Memory Map	
Location	Description
10FFF0–	Extended memory
100000–10FFEF	High memory area
0F0000–0FFFFF	System BIOS
0E0000–0EFFFF	Video BIOS
0DC000–0DFFFF	Available
0D0000–0DBFFF	PC Card memory
0C0000–0CFFFF	Available
0A0000–0BFFFF	Video RAM
09FC00–09FFFF	PS/2 mouse-data area
000000–09FBFF	Conventional memory

Conventional Memory Map		
Segment	Address Range	Use
0	00000h–003FFh	Interrupt vector table
	00400h–004FFh	BIOS data area
	00500h–005FFh	MS-DOS® work area
	00600h–0FFFFh	User memory
1	10000h–1FFFFh	User memory
2	20000h–2FFFFh	User memory
3	30000h–3FFFFh	User memory
4	40000h–4FFFFh	User memory
5	50000h–5FFFFh	User memory
6	60000h–6FFFFh	User memory
7	75000h–7FFFFh	User memory
8	80000h–8FFFFh	User memory
9	90000h–9FBFFh	User memory
	9FC00h–9FFFFh	PS/2 mouse-data area

Connectors

Serial (DTE)	9-pin connector; 16550-compatible, 16-byte buffer
Parallel	25-hole connector; normal (unidirectional), bidirectional, EPP 1.9, or ECP
Monitor	15-hole connector
PS/2 keyboard/mouse	6-hole mini-DIN connector
Infrared	IrDA 1.1 port
Expansion/docking connector	240 pins
TV-out	S-video (composite video supported with adapter cable)
Audio	microphone in, line-out, and line-in connectors
USB	4-pin connector
RJ11	RJ11 modem port (optional)

Integrated Audio

Audio type	Sound Blaster Pro-compatible voice and music functions, HRTF 3D positional audio, hardware wavetable
Audio controller	ESS Technology Maestro-2E
Conversion	16-bit (stereo analog-to-digital and digital-to-analog)
Hardware wavetable synthesizer	wavetable synthesizer 64-voice
Interfaces:	
Internal	PCI bus, microphone, dual stereo speakers
External	microphone in, line-out, and line-in connectors
Internal speaker amplifier	1.0-W total (0.5 W for each speaker)
External microphone input voltage range	280 mV peak-to-peak
Line/audio input voltage range	2.8 V peak-to-peak
Controls	keyboard commands, button, and application program menus

Video

Video type	64-bit (128-bit hardware-accelerated) AGP
Video controller	8- or 16-MB ATI Rage-Mobility P AGP
Video memory	8- or 16-MB 125-MHz SGRAM
LCD interface	65-MHz LVDS
TV support	NTSC or PAL in S-video and composite modes
Maximum resolution/colors	32-bit*

**The video controller supports SXGA (1280 x 1024) and UXGA (1600 x 1200) display resolutions on external monitors that support these resolutions.*

Text Modes		
Resolution	Color Depth	Refresh Rate (Hz)
360 x 400	16	60
720 x 400	16	60
720 x 400	mono	60

Graphics Modes		
Resolution	Color Depth	Refresh Rate (Hz)
4-MB Video Controllers		
640 x 480	256 colors	60
640 x 480	16 bit	60
640 x 480	24 bit	60
640 x 480	32 bit	60
800 x 600	256 colors	60
800 x 600	16 bit	60
800 x 600	24 bit	60
800 x 600	32 bit	60
1024 x 768	256 colors	60
1024 x 768	16 bit	60
1024 x 768	24 bit	60
1024 x 768	32 bit	60
1280 x 1024	256 colors	60
1280 x 1024	16 bit	60
1280 x 1024	24 bit	60
1400 x 1050	256 colors	60
1400 x 1050	16 bit	60
1600 x 1200	256 colors	60
1600 x 1200	16 bit	60
8-MB and 16-MB Video Controllers		
640 x 480	256 colors	60
640 x 480	16 bit	60
640 x 480	24 bit	60
640 x 480	32 bit	60
800 x 600	256 colors	60
800 x 600	16 bit	60
800 x 600	24 bit	60
800 x 600	32 bit	60
1024 x 768	256 colors	60
1024 x 768	16 bit	60
1024 x 768	24 bit	60
1024 x 768	32 bit	60
1280 x 1024	256 colors	60
1280 x 1024	16 bit	60
1280 x 1024	24 bit	60
1280 x 1024	32 bit	60
1400 x 1050	256 colors	60
1400 x 1050	16 bit	60
1400 x 1050	24 bit	60
1400 x 1050	32 bit	60
1600 x 1200	256 colors	60
1600 x 1200	16 bit	60
1600 x 1200	24 bit	60

1600 x 1200	32 bit	60
-------------	--------	----

 **NOTES:** If using an external monitor, see the documentation that came with the external monitor to determine the correct refresh rate.

You may need to adjust the vertical and horizontal size and position controls on your external monitor to properly display extended-video modes.

Physical

14-Inch Display (XGA and SXGA+)

Type	active-matrix color (XGA)
Dimensions (viewable image area):	
Height	37.7 mm (1.5 inches)
Width	324 mm (12. inches)
Depth	259 mm (10.2 inches)
Weight*	3.068 kg (6.75 lb)
Maximum supported resolution	1024 x 768
Refresh rate	60 Hz

* Includes hard-disk drive, diskette drive, and CD-ROM drive. Total computer weight is less with the travel module installed.

15-Inch Display (XGA)

Type	active-matrix color (XGA)
Dimensions (viewable image area):	
Height	40.4 mm (1.6 inches)
Width	324 mm (12.8 inches) with a 3-mm overhang on each side
Depth	259 mm (10.2 inches) with an 8-mm overhang on the front
Weight*	3.378 kg (7.43 lb)
Maximum supported resolution	1024 x 767
Refresh rate	60 Hz

* Includes hard-disk drive, diskette drive, and CD-ROM drive. Total computer weight is less with the travel module installed.

15-Inch Display (UXGA)

Type	active-matrix color (XGA)
Dimensions (viewable image area):	
Height	40.4 mm (1.6 inches)
Width	324 mm (12.8 inches) with a 3-mm overhang on each side
Depth	259 mm (10.2 inches) with an 8-mm overhang on the front
Weight*	3.378 kg (7.43 lb)
Maximum supported resolution	1600 x 1200

Refresh rate 60 Hz

** Includes hard-disk drive, diskette drive, and CD-ROM drive. Total computer weight is less with the travel module installed.*

15-Inch Display (SXGA+)

Type active-matrix color (SXGA)

Dimensions (viewable image area):

Height 40.4 mm (1.6 inches)

Width 324 mm (12.8 inches) with a 3-mm overhang on each side

Depth 259 mm (10.2 inches) with an 8-mm overhang on the front

Weight* 3.427 kg (7.54 lb)

Maximum supported resolution 1400 x 1050

Refresh rate 60 Hz

** Includes hard-disk drive, diskette drive, and CD-ROM drive. Total computer weight is less with the travel module installed.*

Keyboard

Number of keys 87 (U.S. and Canada); 88 (Europe); 90 (Japan)

Key travel 3.0 ± 0.5 mm (0.12 ± 0.02 inch)

Key spacing 19.1 mm (0.75 inch)

Layout QWERTY/AZERTY/Kanji

Touch Pad

Interface PS/2-compatible

X/Y position resolution (graphics table mode) 20 points/mm (500 points/inch)

Size:

Thickness 4.65 mm (0.18 inch) at highest component

Width 64-mm (2.52-inch) sensor-active area

Height 47.0-mm (1.85-inch) rectangle with 0.5-mm (0.02-inch) tabs

Weight 15 g (0.52 ounce) \pm 0.5 g (0.001 ounce)

Power:

Supply voltage 5 V \pm 10%

Supply current 4 mA (maximum operating current)

Battery

Type lithium ion

Dimensions:

Height	23.8 mm (0.94 inch)
Depth	148.2 mm (5.83 inches)
Width	116.2 mm (4.58 inches)
Weight	0.60 kg (1.32 lb)
Voltage	14.4 VDC
Capacity	52 WH
Charge time (approximate)*	2.5 to 3.5 hours (computer on); 3 hours (computer off)
Operating time (approximate)*	3 to 3.5 hours with one battery; 4 to 6 hours with two batteries
Life span (approximate)*	400 discharge/charge cycles
Ambient temperature range:	
Charge	0° to 40°C (32° to 104°F)
Discharge	0° to 60°C (32° to 140°F)
Storage	-20° to 50°C (-4° to 122°F)

** Battery performance features such as charge time, operating time, and life span can vary according to the conditions under which the computer and the battery are used.*

AC Adapter

Input voltage	100 to 240 VAC
Input current (maximum)	1.5 A at 90 VAC, full load
Input frequency	50 to 60 Hz
Output current	3.5 A (continuous)
Output power	70 W
Rated output voltage	19 VDC
Dimensions:	
Height	30.0 mm (1.12 inches)
Width	62.0 mm (2.4 inches)
Depth	110 mm (4.3 inches)
Weight (with cables)	0.32 kg (0.71 lb)
Temperature range:	
Operating	0° to 40°C (32° to 104°F)
Storage	-20° to 65°C (-4° to 149°F)

Environmental

Temperature:	
Operating	5° to 35°C (41° to 95°F)
Storage	-20° to 50°C (-4° to 122°F)

Relative humidity	10% to 90% (noncondensing)
Maximum vibration:	
Operating	0.9 GRMS using a random-vibration spectrum that simulates air/truck shipment
Storage	1.3 GRMS using a random-vibration spectrum that simulates air/truck shipment
Maximum shock:*	
Operating	1.52 m/sec (4.98 ft/sec) (less than or equal to a pulse width of 2 ms)
Storage	2.03 m/sec (6.66 ft/sec) (less than or equal to a pulse width of 2 ms)
Altitude:	
Operating	0 to 3048 m (0 to 10,000 ft)
Storage	0 to 12,192 m (0 to 40,000 ft)

* Measured with the hard-disk drive in head-parked position

Regulatory

U.S.	FCC Class B
Canada	IC Notice
Europe	CE NOTICE: EN 55022, EN 50082-1, IEC 801-2, IEC 801-3, IEC 801-4, EN 60950:1992 + Amd.1:1993 + Amd.2:1993
Czech Republic	EN 55022 Compliance
Japan	VCCI Class A or Class B ITE
Poland	PN-93/T-42107 and PN-EN 55022
Mexico	NOM 024

[Back to Contents Page](#)

System Messages: Dell™ Inspiron™ 5000 Series

 [Overview](#)

 [System Messages](#)

Overview

The operating system, application programs, and the computer itself can generate status and error information. This section explains the system messages generated by the basic input/output system (BIOS). For other messages, refer to the application program or operating system documentation.

System Messages

If a message appears on the display or external monitor, make a note of the message. See the following table for an explanation of the message and suggestions for correcting errors. The system messages are listed alphabetically.

 **NOTE:** If the message is not listed in the following table, check the documentation for the application programs that were running at the time the message appeared and/or the operating system documentation for an explanation of the message and recommended action.

Message	Cause	Action
Diskette drive A error	A connector may be loose, or the diskette may be faulty.	If the diskette-drive access indicator lights up when you access a file on the diskette, but you still get this error message, try a different diskette. If using a different diskette does not solve the problem, restart the computer. If the problem persists, call Dell for technical assistance.
Fixed disk 0 failure	The hard-disk drive failed to initialize.	See "Resolve Hard-Disk Drive Problems" in Chapter 2 of the <i>Dell Inspiron 5000 Reference and Troubleshooting Guide</i> or "Drive Problems" in Chapter 2 of the <i>Dell Inspiron 5000e Solutions Guide</i> .
Fixed disk controller failure	The hard-disk drive controller may be faulty.	Call Dell for technical assistance.
Keyboard controller error	The keyboard controller is faulty.	Call Dell for technical assistance.
Keyboard error	If an external keyboard is being used, a cable or connector may be loose or the keyboard may be faulty. If the integrated keyboard is being used, it may be faulty. A key on the integrated keyboard may have been pressed while the computer was booting.	Run the Stuck Key Test in the PC-AT Compatible Keyboards device group in the Dell Diagnostics.
Operating system not found	The operating system may be corrupted. Or, the operating system cannot be found on the hard-disk drive or on the diskette in the diskette drive.	Reinstall the operating system. See the documentation that came with the operating system. If the problem persists, call Dell for technical assistance.
Real time clock error	The CMOS battery that supports data stored in NVRAM may be dead.	Call Dell for technical assistance.
CMOS battery is dead— Replace and run Setup	The CMOS battery is dead.	Call Dell for technical assistance.
System CMOS checksum bad—run Setup	The BIOS has been updated. CMOS has been corrupted or modified, possibly by an application program that changes data stored in CMOS.	Enter the system setup program by restarting the computer and pressing <F2> as soon as the Dell logo appears. Reconfigure the system. If the problem persists, call Dell for technical assistance.



NOTE: For the full name of an abbreviation or acronym used in this table, see the Glossary in the system Help.

[Back to Contents Page](#)